

www.netzerotools.com

SC420 OPTI-FIT™ CBRN POWERED AIR-PURIFYING RESPIRATOR (PAPR)

OPERATION AND MAINTENANCE INSTRUCTION MANUAL



WARNING

DO NOT USE this respirator until you completely read and understand this instruction manual. You are required to inspect the respirator prior to putting it into service. Please refer to the inspection procedures in this manual. Failure to comply with this warning may result in personal injury, illness, or death.



NetZeroTools
800-577-6389

www.netzerotools.com

www.netzerotools.com

Table of Contents

NIOSH APPROVAL CAUTIONS AND LIMITATIONS	1
I. INTRODUCTION	1
II. SAFETY PRECAUTIONS	2
III. DESCRIPTION	2
IV. PARTS LIST	4
V. USE INSTRUCTIONS	5
A. Battery Packs and Charging	5
B. How to Inspect for CBRN Compliance	9
C. Canister Installation	10
D. Pre-operational Flow Check	11
E. Donning	12
F. How to Select a Facepiece Size	13
G. Fit Check	14
H. Using the Respirator	14
I. Doffing	14
J. Canister Service Life and Replacement	15
K. Decontamination	16
VI. MAINTENANCE	17
A. Cleaning	17
B. Inspection	18
C. Repair	18
VII. SHIPMENT	18
VIII. OVERHAUL FREQUENCY	18
IX. STORAGE AND TRANSPORTATION	18
A. Facepiece, Blower, and Breathing Hose Assembly	19
B. Canister	19
X. ADDITIONAL INFORMATION	19
XI. WARRANTY AND LIMITATION OF LIABILITY	20
XII. REFERENCES	20
XIII. INSPECTION TABLE	21
XIV. REPAIR TABLE	23
XV. ACRONYMS	25

NIOSH APPROVAL CAUTIONS AND LIMITATIONS

- A - Not for use in atmospheres containing less than 19.5 percent oxygen.
- F - Do not use powered air-purifying respirators if airflow is less than four cfm (115 lpm) for tight fitting facepieces or six cfm (170 lpm) for hoods and/or helmets.
- H - Follow established cartridge and canister change schedules or observe ESLI to ensure that cartridges and canisters are replaced before breakthrough occurs.
- I - Contains electrical parts that may cause an ignition in flammable or explosive atmospheres.
- J - Failure to properly use and maintain this product could result in injury or death.
- L - Follow the manufacturer's User's Instructions for changing cartridges, canisters, and/or filters.
- M - All approved respirators shall be selected, fitted, used, and maintained in accordance with MSHA, OSHA, and other applicable regulations.
- N - Never substitute, modify, add, or omit parts. Use only exact replacement parts in the configuration as specified by the manufacturer.
- O - Refer to User's Instructions and/or maintenance manuals for information on use and maintenance of these respirators.
- R - Some CBRN agents may not present immediate effects from exposure, but can result in delayed impairment, illness, or death.
- S - Special or critical User's Instructions and/or specific use limitations apply. Refer to User's Instructions before donning.
- Y - The respirator provides respiratory protection against inhalation of radiological and nuclear dust particles. Procedures for monitoring radiation exposure and full radiation protection must be followed.
- Z - If during use, an unexpected hazard is encountered such as a secondary CBRN device, pockets of entrapped hazard, or any unforeseen hazard, immediately leave the area for clean air.
- BB - Not for use for entry into atmospheres immediately dangerous to life or health.

CC - For entry, do not exceed maximum use concentrations established by regulatory standards.

GG - Direct contact with CBRN agents requires proper handling of the respirator after use. Correct disposal procedures must be followed.

UU - The respirator should not be used beyond eight (8) hours after initial exposure to chemical warfare agents to avoid possibility of agent permeation. If liquid exposure is encountered, the respirator should not be used for more than two (2) hours.

VV - PAPRs with TC-23C approvals may NOT be used for escape from IDLH atmospheres.

I. INTRODUCTION

This manual provides instructions for the use and maintenance of the Sperian SC420 Powered Air-Purifying Respirator (PAPR) with the Opti-Fit™ Gas Mask facepiece. The PAPR uses SC420 Opti-Fit Gas Mask full facepiece Models 7590, 7690, 7790, 7595, 7695, 7795, and CBRN Canister Model 1690. **You must read and understand this manual and be trained in the proper use of the respirator before wearing it in a contaminated atmosphere.**

The term "contaminant" as used in this manual refers to chemical, biological, radiological, or nuclear (CBRN) warfare agents, toxic industrial chemicals (TIC), toxic industrial materials (TIM), or other substances which may cause serious injury, illness, or death.

The SC420 PAPR is a CBRN-compliant PAPR intended for use by emergency responders, trained to respond to a chemical, biological, radiological, or nuclear incident. Emergency responders are generally fire, emergency medical, and law enforcement personnel, although there may be other public or private agencies acting in supportive roles who may require CBRN protection while performing their duties. Users of the SC420 PAPR must understand that the types and concentrations of contaminants in a CBRN event are unpredictable and may vary greatly from one incident to another. In general, an Incident Command System (ICS) will be deployed at a CBRN event to characterize the type and concentration of contaminant(s); establish control zones and identify the required Personal Protective Equipment (PPE); define exposure limits; canister changeout schedules; and decontamination protocols. While the ICS may vary in size depending on the extent of the CBRN event, it will always include an Incident Commander (IC) who will be responsible for on-scene management of the response effort. This comprehensive approach to incident management has been established by the National Incident Management System (NIMS) under the Department of Homeland Security (DHS).

Further information on command, control, and coordination of emergency response efforts can be obtained by contacting your Federal Emergency Management Agency (FEMA) Regional Training Manager. Information on existing and emerging CBRN standards and emergency responder guides can be obtained from the National Institute for Occupational Safety and Health (NIOSH) through the National Personal Protective Technology Laboratory (NPPTL) website www.cdc.gov/niosh/npptl/. Additional references are listed in section XII of this instruction manual.

II. SAFETY PRECAUTIONS

The Warnings, Cautions, and Notes contained in this manual have the following significance:

 WARNING
Maintenance or operating procedures and techniques that may result in personal injury, illness, or death if not carefully followed.
CAUTION
Maintenance or operating procedures and techniques that may result in damage to equipment and/or minor to moderate personal injury if not carefully followed.

NOTE

Maintenance or operating procedures and techniques or information considered important enough to emphasize.

III. DESCRIPTION

The Sperian SC420 PAPR consists of a tight-fitting butyl rubber facepiece, a rubber breathing tube, a belt mounted blower with two (2) CBRN canisters and a Lithium Battery. An optional Nickel Metal Hydride (NiMH) rechargeable battery pack and non-rechargeable alkaline battery pack are available. The optional alkaline battery pack allows for use of commercially available "D" cell alkaline batteries (4 each required). The blower operates at a single speed, providing a constant flow of breathing air to the facepiece worn by the user. Ambient air is first filtered through two canisters as it is drawn into the blower inlet, through the blower unit, and then out of the blower into the breathing hose attached to the facepiece assembly. The breathing hose is attached to one of two side port connectors on the facepiece assembly by means of a 90 degree RD40 threaded elbow. The elbow has four broad finger tabs to ease attachment and removal of the hose with gloved hands. A toggle switch (ON/OFF) is located just below the outlet port of the blower for powering it on and off. A Flowmeter, P/N 769516, is provided with the blower for the user to verify the blower is operating at the required minimum flow. Filtered breathing air is provided to the facepiece at a minimum flow rate of 115 liters per minute (4 cubic feet per minute). To maintain NIOSH approval, only the equipment and accessories listed on the appropriate NIOSH approval label may be used together.

The full facepiece is designed with a wide lip butyl skirt and Kevlar headnet harness with optional drink tube. An optional full facepiece is available with the 5-strap head harness and optional drink tube. All facepieces contain a lens treated with an abrasion-resistant coating. The facepieces are available in three sizes: small, medium, and large. A dry formulation anti-fog wipe is available as an accessory. Along with the standard nose cup, the facepiece may also be equipped with an optional spectacles kit, clear or

tinted lens covers, and a neck strap. Optional small and large nose cups are also available.

When used in accordance with the instructions provided in this document, the Opti-Fit CBRN PAPR and CBRN canister provide respiratory protection against CBRN contaminants in accordance with the NIOSH Statement of Standard for CBRN Powered Air Purifying Respirators. The standard identifies canister service life with the designators "Cap 1, 2, or 3". The minimum protection times in the table below are as tested against representative agents and concentrations identified in the standard.

Designator	Minimum Protection Time
Cap 1	15 minutes
Cap 2	30 minutes
Cap 3	45 minutes

The type and amount of contaminant(s) encountered when responding to a CBRN event are unpredictable and will vary from one incident to another. You must always follow instructions provided by the ICS to know how long you can safely use the gas mask and canister. The ICS will analyze the contaminated area(s) for the type and concentration of contaminant(s) to provide objective information and data, ensuring that each canister is changed out before the end of its service life and that maximum exposure times are not exceeded for the PPE in use.

The Sperian CBRN Canister Model 1690 is certified to provide protection at level Cap 1. This protection designator is printed on the canister label beneath the model number.

Before wearing this gas mask in a CBRN environment, the user should consider the use of dermal protection against splashes. Failure to do so may result in personal injury even when the respirator is properly fitted, used, and maintained. When used with non-encapsulating chemical resistant clothing generally consisting of a hood, coveralls, gloves, and chemically resistant boots or boot covers, a CBRN tight fitting PAPR will provide Level C protection. Do not use beyond eight (8) hours after initial exposure to chemical agents to avoid possibility of agent permeation. If liquid exposure is encountered, do not use the respirator more than two (2) hours.

 WARNING
<ul style="list-style-type: none"> • For use by trained, qualified personnel only. • All persons using this Sperian SC420 PAPR must be made aware of its limitations. We cannot be responsible for any damage to property, personal injury, or death in which environmental exposure is a contributing factor. • This PAPR must be worn and used as specified in Sperian's instructions. No PAPR can provide complete protection from all conditions. Use extreme care in all emergency conditions.

⚠ WARNING—Continued

- This PAPR may provide less than adequate protection if improperly used, which may result in personal injury, illness, or death.
- The materials of this respirator can be chemically attacked if exposed to contaminants or decontaminants and may exhibit excessive corrosion or other forms of damage. Permeation or penetration of gases, liquids or particles through the materials could be excessive. Extremes of temperature might cause thermal degradation. Each of these things, or a combination of them, could create conditions in which this Sperian SC420 PAPR would be dangerous to use.
- Do not use this PAPR if anything comes between the facepiece and your face (e.g., hair, facial hair, bandanna, head covering, etc.). This condition will prevent a good facepiece seal and may allow the leakage of contaminants into the facepiece.
- Do not use this PAPR in environments where the concentrations of contaminants are unknown or are immediately dangerous to life or health (IDLH). IDLH atmospheres are defined as:
 - a. Those that the wearer could not breathe for short periods.
 - b. Those from which the wearer could not escape without the aid of a gas mask.
 - c. Those which have an immediate or delayed adverse effect on health.
- This gas mask does not supply oxygen. Do not use in atmospheres containing less than 19.5% oxygen by volume.
- Contaminants must be fully characterized before entering a CBRN environment. Seek guidance from the IC or ICS for the incident to which you are responding.
- Before entering any environment while wearing this PAPR, testing must be conducted to characterize contaminants and determine if the environment could render the gas mask unsafe. Seek guidance from the IC or ICS for the incident to which you are responding.
- Do not use this PAPR without Sperian canisters securely attached to the blower. Always read the canister label prior to use and be certain that the canister you have will provide the required protection. This PAPR must be used for protection against only those air contaminants listed on the canister and/or the NIOSH approval label.
- Do not use this PAPR at ambient temperatures above 130°F (55°C).
- Do not use this PAPR where environmental conditions could cause the facepiece to be dislodged or slip.

⚠ WARNING—Continued

- Immediately return to a non-contaminated area if:
 - a. You taste or smell contaminants or if your eyes, nose, or throat become irritated.
 - b. Breathing becomes difficult.
 - c. The air you are breathing becomes uncomfortably warm.
 - d. You feel nauseous or dizzy.
 - e. You notice a loss or decrease in airflow.
 - f. The facepiece moves, slips, or leaks.
- This PAPR does not protect exposed areas of the body. Some contaminants can be absorbed directly through the skin and others may burn or irritate exposed areas. Use the PAPR in conjunction with PPE that provides appropriate levels of protection against dermal hazard. Failure to do so may result in personal injury or death.
- This PAPR does not provide protection from hazardous rays or harmful noise. Always wear proper head, eye, and ear protection.
- This PAPR must not be used underwater, for fumigation, interior structural fire fighting, abrasive blasting operations, or in areas where high heat, sparks, or flames could contact the PAPR.
- Do not wear this PAPR if a satisfactory fit, as determined by a qualitative or quantitative fit test, cannot be obtained. (Note for CBRN applications: a quantitative fit test must be performed.) See ANSI Z88.2, latest issue, and OSHA 29 CFR 1910.134, latest edition. Beards, stubble, or sideburns will prevent a good facepiece seal, and facial hair may interfere with valve function. Do not use this PAPR unless you are clean shaven. Absence of one or both dentures, the presence of deep facial scars, etc., can seriously affect the fit of the facepiece.
- Use of components other than those listed on the NIOSH approval label and in this manual, or as authorized by Sperian, or modification of this PAPR in any manner will void the NIOSH certification and invalidates all Sperian's warranties for the PAPR. Accessories not offered by Sperian may degrade performance, and will void NIOSH certification.
- Follow additional instructions and guidance provided by the IC or ICS for the incident to which you are responding, including the type and concentration of contaminant(s), location of control zones, decontamination protocols, and canister changeout schedule.
- Do not use if you have a preexisting skin condition (for example, folliculitis or vitiligo) until you obtain clearance from a medical doctor.

⚠ WARNING—Continued

- Always read and follow the instructions listed in the Material Safety Data Sheet for the chemicals that are present in the work area.
 - Some individuals are sensitive to chemicals (e.g., isocyanates, latex, oil mists, etc.) or may have some type of respiratory disorder (e.g., asthma, chronic obstructive airway disease, etc.). If you are sensitive to any chemical or have a respiratory disorder, you may have a severe reaction at contaminant levels well below accepted health levels, such as the OSHA Permissible Exposure Limit (PEL), ACGIH® Threshold Limit Value (TLV®), or the NIOSH Recommended Exposure Limits (REL). Many chemicals (e.g., isocyanates, mercury, etc.) have no physical warning properties and you cannot taste or smell the contaminants even though they may be present in the facepiece. This PAPR will reduce, but will not eliminate the possibility of contaminants entering the facepiece and causing a severe reaction. Do not use this PAPR until you obtain clearance from a medical doctor.
 - Where suspected cancer-causing contaminants are present, positive-pressure supplied-air respirators will provide higher protection levels.
 - This PAPR must be cleaned and maintained in accordance with Sperian's instructions.
 - The PAPR facepiece assembly contains natural rubber latex, which may cause allergic reactions in some individuals. Discontinue use if you experience an allergic reaction.
 - Discontinue use if you experience skin irritation or discoloration.
 - Do not use this PAPR if it has been left exposed in a contaminated environment. Contaminants can collect on the inside of the facepiece and be inhaled when the gas mask is donned.
 - Routinely used PAPRs must be inspected before and after each use, and at least every 30 days. A written record must be kept of emergency respirator inspections.
- FAILURE TO OBSERVE ALL WARNINGS MAY RESULT IN PERSONAL INJURY, ILLNESS, OR DEATH.**

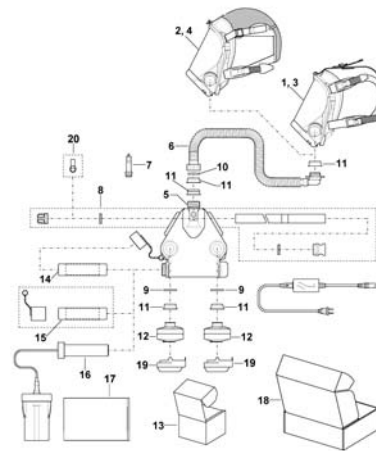

Figure 1A

Figure 1a. SC420 PAPR
IV. PARTS LIST (See Figure 1a)

The items shown in Figure 1a and identified below are required for a complete PAPR system.

ITEM	QTY	P/N	DESCRIPTION
1	1	759001	Facepiece, 5-Strap, Small
	1	769001	Facepiece, 5-Strap, Medium
	1	779001	Facepiece, 5-Strap, Large
2	1	759501	Facepiece, Headnet, Small
	1	769501	Facepiece, Headnet, Medium
	1	779501	Facepiece, Headnet, Large
3	1	759011	Facepiece, 5-Strap, w/Drink, Small
	1	769011	Facepiece, 5-Strap, w/Drink, Medium
	1	779011	Facepiece, 5-Strap, w/Drink, Large
4	1	759511	Facepiece, Headnet, w/Drink, Small
	1	769511	Facepiece, Headnet, w/Drink, Medium
	1	779511	Facepiece, Headnet, w/Drink, Large
5	1	769512	SC420 Blower Assembly
6	1	769515	Breathing Hose Assembly
7	1	769516	Flowmeter
8	1	769540	Decon Belt Assembly
9	2	769519	Gasket, Blower
10	1	769549	Gasket, Breathing Hose
11	3	769518	Caplug
12	2	169001	CBRN Canister
13	2	169006	Storage Box, CBRN Canister
14	1	769532	Lithium Battery Pack (Non-rechargeable)
15	1	769531	NiMH Rechargeable Battery Pack
16	1	769535	Alkaline D-cell Battery Pack
17	1	940118	Storage Bag, Facepiece Assembly
18	1	769584	Storage Box, Batteries
OPTIONAL ACCESSORIES			
19	2	769513	Filter Shower Cap
20	*	964869	D-ring Kit

* As required.

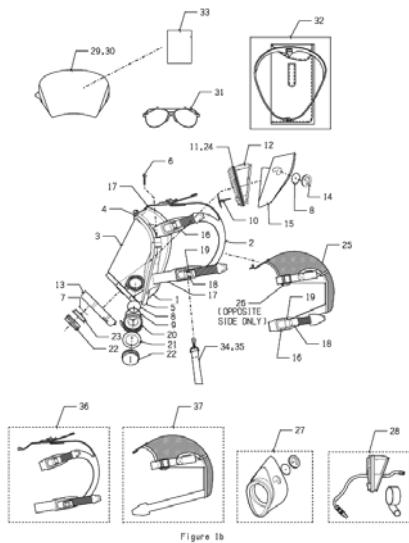

**Figure 1b. Opti-Fit Gas Mask Models
7590/7690/7790/7595/7695/7795
Facepiece Components Parts List (See Figure 1b)**

ITEM	QTY	P/N	DESCRIPTION
1	1	962158	Small Skirt, Black
	1	962168	Medium Skirt, Black
	1	962176	Large Skirt, Black
2	1	962114	Headstrap
3	1	702007	Lens
4	1	962031	Upper Rim
5	1	962037	Lower Rim
6	2	839102	Screw
7	Pkg. of 6	763021	Inhalation Valve
8	4	54140215	Inhalation Valve (RP187)
9	Pkg. of 2	702037	Twin Seal
10	Pkg. of 4	B140005	Exhalation Valve
11	1	820261	O-ring
12	1	702013	Nozzle
13	1	702082	Nozzle Cover
14	2	962090	Valve Holder
15	1	702023	Nose Cup
16	2	962819	Short Buckle Strap
17	3	962818	Long Buckle Strap
18	5	968975	Buckle
19	5	702008	Ring
20	2	702005C	Canister Connector
21	2	702057	Gasket, Black (EPDM)
22	2	962066	Plug
23	1	763501	Gasket/Valve Seat
24	1	910452	Chistolube Lubricant
25	1	969018	Headnet
26	1	960104	Split Ring

OPTIONAL ACCESSORIES		
	P/N	DESCRIPTION
27	702069	Nose Cup Kit, Small, Black
	702070	Nose Cup Kit, Medium, Black
	702071	Nose Cup Kit, Large, Black
28	769015	Drink Tube Kit
29	702028	Peel-away Lens Cover, Clear (25)
30	702019	Peel-away Lens Cover, Tinted (25)
31	962260	Spectacles Kit
32	964044	Spectacles Kit, NexSpex™
33	981808	Wipe, Dry, Anti-fog (Box of 100)
34	702031	Neck Strap Kit
35	962869	Neck Strap Kit, TwentyTwenty Plus
36	769538	Head Harness Kit, 5-Strap
37	969019	Headnet Kit, TwentyTwenty

NOTE

This product is subject to export regulation by agencies of the U.S. Government, including the U.S. State Department Office of Defense Trade Controls as an item on the U.S. Munitions List and subject to the International Traffic In Arms Regulations (ITAR), set forth at 22 CFR Parts 120 through 129. Accordingly, any export of this product must be made pursuant to an appropriate export license issued by the Office of Defense Trade Controls by the U.S. Department of Commerce and must comply with the ITAR provisions and all other applicable U.S. Export control laws.

Use only components having part numbers listed on the NIOSH approval label. Use of any other components voids the approval.

V. USE INSTRUCTIONS

A. Battery Packs and Charging

There are three optional battery packs for the SC420 PAPR. They are a non-rechargeable Lithium-Sulfur Dioxide (LiSO₂), rechargeable Nickel Metal Hydride (NiMH), and an Alkaline "D" Cell Battery Pack. Instructions for installation and use of each battery option are as follows.

1. Non-rechargeable Lithium-Sulfur Dioxide (LiSO₂) Battery Pack:

The LiSO₂ Battery Pack is a non-rechargeable battery with a minimum run-time of 4 hours when used with the SC420 blower and Opti-Fit facepiece. The advantage of the LiSO₂ battery is that it has a long shelf life, good for a minimum of 10 years when stored under conditions as specified in this manual. Perform the following steps to install and use the LiSO₂ battery.

**WARNING**

Do not use any battery which shows signs of damage such as bulging, swelling, torn, cut, or otherwise ruptured outer covering, swollen plastic wrap, or liquid under the plastic wrap. Failure to comply with this warning may lead to personal injury, illness, or death.

The Lithium-Sulfur Dioxide (Li-SO₂) Battery used in this equipment contains pressurized Sulfur Dioxide (SO₂) gas. The gas is toxic and the battery must not be abused in any way which may cause the battery to rupture. Do not handle the battery directly if you detect an odor like that of vinegar or rotten eggs. Such odor indicates possible leakage of and exposure to battery gas, which can lead to personal injury, illness, or death.

**WARNING**

The use of batteries beyond their expiration date may result in marginal blower performance, providing inadequate respiratory protection to the user. Always use batteries that are within their expiration date. Failure to comply with this warning may lead to personal injury, illness, or death.

- a. Verify battery is within its expiration date by checking for the expiration date on the packaging label.
- b. Remove battery from protective packaging. Inspect battery for signs of damage.

**WARNING**

Be sure the switch is set to the "OFF" or "0" position before installing or replacing the battery. Damage may occur to the battery if the switch is on when the battery is installed. Failure to comply with this warning may lead to personal injury, illness, or death.

- c. Ensure the SC420 Blower ON/OFF switch is set to the OFF position.
- d. Unscrew and remove the cap on the blower battery compartment. The cap is tethered to the blower by a lanyard to prevent loss.
- e. Install the battery into the battery compartment by inserting the end with the contacts first. The orientation is illustrated on a label affixed to the inside of the battery compartment. See Figure 2.
- f. Screw the cap back onto the battery compartment all the way until hand tight against the compartment housing.



Figure 2. Non-rechargeable Li-SO₂ Battery Pack Installation

- g. The battery is now installed. Before use, perform a Pre-Operational Flow Check in accordance with the procedures contained in this manual.

2. Rechargeable Nickel-Metal Hydride (NiMH) Battery Pack:

The NiMH Battery Pack is a rechargeable battery with a minimum run-time of 4 hours when used with the SC420 blower. The advantage of the NiMH Battery is that for periodic operation of the blower, it is a more cost effective source of power, for example, when compared to the LiSO₂ Battery Pack. This is because the NiMH Battery Pack can be recharged hundreds of times whereas a non-rechargeable requires replacement once depleted. Perform initial inspection, cap installation, and conditioning steps below for new batteries only. For batteries already "In Service," perform the steps following the new battery steps to install and use the NiMH Battery Pack.

- a. For new NiMH batteries, perform the following steps before use.

**WARNING**

Do not use any battery which shows signs of damage such as bulging; swelling; torn, cut, or otherwise ruptured outer covering; swollen plastic wrap; or liquid under the plastic wrap. Failure to comply with this warning may lead to personal injury, illness, or death.

- 1) Remove the battery and green cap with lanyard from protective packaging. Inspect the battery and cap/lanyard for signs of damage.

NOTE

The NiMH battery comes with a separate battery compartment cap which is made to fit the longer length of the pack. Ensure you replace the black cap used for the LiSO2 battery with the green cap used for the NiMH battery; otherwise, you will not be able to install the NiMH battery into the blower.

2) Unscrew the black cap installed on the battery compartment of the blower, and completely remove the cap and lanyard by detaching the lanyard split ring from the blower housing. Install the green cap that came with the NiMH Battery Pack by attaching the split ring on the lanyard to the blower housing. Then, screw the cap onto the blower battery compartment.

 WARNING
<p>New NiMH Battery Packs must be conditioned to provide the minimum run-time stated in this manual. A new NiMH battery which has not been properly conditioned may not provide adequate run-time, causing the blower to shut down before expected. Condition the battery by performing three charge/discharge cycles. Failure to comply with this warning may lead to personal injury, illness, or death.</p>

Battery Conditioning:

3) Connect the charger power cord to the charger, and plug the power cord into a 100 to 240v power source. When connected to power with no battery attached, the charger light should be orange. Insert the battery plug on the charger cord into the receptacle on the battery. Within approximately 20 seconds, the charger light should turn red when connected to an uncharged battery. (See the Repair Table if the charger light color is other than expected.) Charge the battery for six (6) hours, verify the charger light is solid green, then disconnect the battery from the charger.

 WARNING
<p>Be sure the switch is set to the "OFF" or "0" position before installing or replacing the battery. Damage to the battery may occur if the switch is on when the battery is installed. Failure to comply with this warning may lead to personal injury, illness, or death.</p>

- 4) Ensure the SC420 Blower ON/OFF switch is set to the OFF position.
- 5) Unscrew the cap from the blower battery compartment.
- 6) Install the battery into the battery compartment by inserting the end with the contacts first. The orientation is illustrated on a label affixed to the inside of the battery compartment. See Figure 3.



Figure 3. Rechargeable NiMH Battery Pack Installation

- 7) Screw the cap back onto the battery compartment all the way until hand tight against the compartment housing. The battery is now installed.
- 8) Turn on the SC420 Blower by flipping the ON/OFF switch to the ON position.
- 9) Run the blower for four hours, then turn it off by flipping the ON/OFF switch to the OFF position.
- 10) Repeat steps 3. through 9. two more times, then stop. The battery is now conditioned.

b. Charging:

For "In-Service" batteries, perform the following steps for charging.

 WARNING
<ul style="list-style-type: none">• Do not use any battery which shows signs of damage such as bulging, swelling, torn, cut, or otherwise ruptured outer covering, swollen plastic wrap, or liquid under the plastic wrap.• The Sperian NiMH Charger, P/N 769545, is for indoor use only and must not be exposed to outdoor elements.

⚠ WARNING—Continued

- **Battery pack charging must be done in a safe, non-hazardous location. Failure to do so may result in injury or death.**
- **Only Sperian P/N 769531 NiMH Battery Packs can be charged with a Sperian P/N 769545 Charger. Charging other types of batteries could cause explosions, resulting in injury or death.**

CAUTION

Sperian recommends that the battery pack be charged at temperatures between 40°F and 80°F (4.5°C and 26.7°C). Charging at higher temperatures may cause a reduction in capacity and may reduce battery pack life.

NOTE

The battery is equipped with an automatic fault protection circuit; no fuse is required.

- 1) Inspect battery for signs of damage.
- 2) Connect the charger power cord to the charger, and plug the power cord into a 100 to 240v power source. When connected to power with no battery attached, the charger light should be orange.
- 3) Insert the battery plug on the charger cord into the receptacle on the battery. Within approximately 20 seconds, the charger light should turn red when connected to an uncharged battery. (See the Repair Table if the charger light color is other than expected.) The six sequential charging modes, LED indicator light colors, State of Charge (SOC) of the battery, and user actions are listed in the table below.

LED	Charging Mode	SOC	User Action
ORANGE	No Battery	Not Applicable	None
ORANGE	Initialization	SOC Query	None
RED	Fast Charge	Discharged	Charge**
GREEN/ ORANGE	Top-off Charge	Partially Discharged	Charge
GREEN	Trickle Charge	Charged	Done*
RED/ GREEN	Error	Fault	Remove Battery and See Repair Table

* New batteries and batteries which have not been used for months can experience a false indication that can cause the GREEN LED indicator to illuminate only a few minutes into the charging cycle. Simply remove

and reinstall the charging plug into the battery to continue the charging cycle. The optimum charging time is 8 hours; however, battery packs can be left in the "Trickle Charge" mode indefinitely.

** In a discharged condition (approximately 4 hours of operational use), the battery pack will charge for approximately 6 hours. Charging times will vary for battery packs in a partial state of charge (SOC).

c. Installation and Use:

⚠ WARNING

Be sure the switch is set to "OFF" or the "0" position before installing or replacing the battery. Damage to the battery may occur if the switch is on when the battery is installed. Failure to comply with this warning may lead to personal injury, illness, or death.

- 1) Ensure the SC420 Blower ON/OFF switch is set to the OFF position.
- 2) Unscrew the cap from the blower battery compartment.
- 3) Install the battery into the battery compartment by inserting the end with the contacts first. The orientation is illustrated on a label affixed to the inside of the battery compartment.
- 4) Screw the cap back onto the battery compartment all the way until it is hand tight against the compartment housing.
- 5) The battery is now installed. Before use, perform a Pre-Operational Flow Check in accordance with procedures contained in this manual.

3. Alkaline D-cell Battery Pack

The Alkaline D-cell Battery Pack is an adapter which allows for use of commercial off-the-shelf (COTS) "D" cell alkaline batteries (4 each required). The Alkaline Battery Pack has a minimum run-time of 4 hours, but typically runs for 8 to 12 hours when used with the SC420 blower. The advantage of the Alkaline Battery Pack is the ability to use batteries that are widely available at retail stores. Perform the following steps for installation and use.

⚠ WARNING

• Alkaline batteries can contain caustic chemicals and, if damaged, these materials may leak out and present a burn hazard by exposure to skin, eyes, or the respiratory tract. Do not use any battery which shows signs of damage such as bulging; swelling; torn, cut, or

⚠ WARNING—Continued

otherwise ruptured outer covering; swollen plastic wrap; or liquid under its outer cover. Inspect batteries before installing them.

• The use of batteries beyond their expiration date may result in marginal blower performance, providing inadequate respiratory protection to the user. Always use batteries that are within their expiration date. Failure to comply with this warning may lead to personal injury, illness, or death.

- a. Verify batteries are within their expiration date by checking for the expiration date on the commercial packaging or battery exterior.
- b. Inspect batteries for signs of damage. Do not use any battery which shows signs of damage.
- c. The Alkaline Battery Pack requires four (4) each D-cell Alkaline Batteries. Remove battery pack lid from case by using fingers to press inward on recessed retaining clips located on the sides of the lid. The lid is tethered to the case to prevent it from being lost.
- d. Install battery cells according to the polarity shown on the labels affixed to the inside of the case. Before snapping the lid back onto the case, make sure the polarity symbols on the lid align with the symbols inside the case. See Figure 4. Snap the lid back onto the battery case.

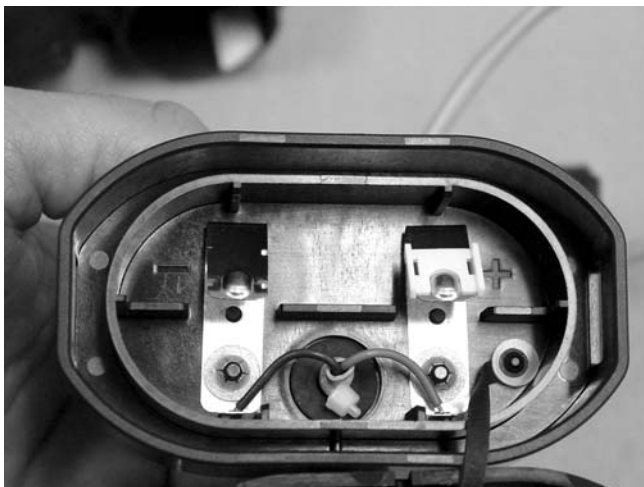

Figure 4. Lid Polarity Symbols

- e. Unscrew the cap from the blower battery compartment and leave it on its tether.
- f. Insert the grey tubular adapter into the battery compartment contacts first. See Figure 5. Hand tighten the adapter cap onto the battery compart-



Figure 5. Alkaline Battery Pack Installation

- ment until it is snug against the compartment housing.
- g. Attach the battery pack onto the PAPR belt using the metal clip on the back of the battery pack.

⚠ WARNING

The operating condition of commercial off-the-shelf (COTS) batteries cannot be determined by expiration date alone. Users must perform a pre-operational flow check before use to verify batteries will work. Failure to comply with this warning may lead to personal injury, illness, or death.

- h. The battery is now installed. Before use, perform a Pre-Operational Flow Check in accordance with procedures contained in this manual.

B. How to Inspect for CBRN Compliance

⚠ WARNING

Some industrial PAPR components may appear similar to CBRN-compliant components but will NOT provide adequate protection in a CBRN environment. Use only components having part numbers listed on the NIOSH approval label. Use of any other components voids the approval. Failure to comply with this warning may lead to personal injury, illness, or death.

Before using the PAPR components and canisters in a CBRN environment, you must first inspect the components and canisters for CBRN compliance. Perform the following steps to inspect the respirator and canisters for CBRN compliance.

⚠ WARNING

Inspect the respirator components and canisters for CBRN compliance prior to use in a CBRN environment. Do not use respiratory devices and/or canisters which are not CBRN compliant. **FAILURE TO COMPLY WITH THIS WARNING MAY LEAD TO PERSONAL INJURY, ILLNESS, OR DEATH.**

1. Verify that the label on the blower assembly shows part number 769512 as shown in Figure 6a.



Figure 6a. Blower Assembly Identification Label

2. Verify that the label on the hose assembly shows part number 769515 as shown in Figure 6b.



Figure 6b. Breathing Hose Assembly Identification Label

3. Verify that the label on the facepiece shows model numbers 7590, 7690, 7790, 7595, 7695, 7795, or the designation "CBRN" as shown in Figure 6c.



Figure 6c. Facepiece Label

4. Verify that the label affixed to the CBRN canisters are olive green in color and do not have a purple strip.

5. Verify that the canister label directly below the model number reads: "CBRN Cap 1" as shown in Figure 6d.



Figure 6d. Canister Label

C. Canister Installation

⚠ WARNING

- Always read canister labels prior to use to be certain that you have canisters that will provide the required protection.
- Only use two (2) canisters of the same type.
- Never use the PAPR without two (2) blower inlet gaskets in place (Figure 2c.). Use of the PAPR without the blower inlet gaskets could allow contaminants to leak into the facepiece.
- The failure to comply with this warning may lead to personal injury, illness, or death.

Before using the Model 1690 CBRN canisters, you must confirm that the atmosphere is non-IDLH and not oxygen deficient. Only use canisters maintained in accordance with section IX, which have been kept in their unopened original foil/poly packaging and cardboard box. Always ensure your replacement filter is within its service life by checking the expiration date in any one of three locations: on the outside label of the canister storage box; on the upper right corner label of the poly/foil bag; or on the olive-colored canister label's far right corner as shown in Figures 7a., 7b., and 7c., respectively.



Figure 7a. Outside Label, Canister Storage Box



Figure 7b. Upper Right Label, Poly/Foil Bag



Figure 7c. Far Right Label, Canister

1. Verify that the rubber gasket is in place at the bottom of the threaded blower outlets as shown in Figure 7d.



Figure 7d. Blower Gaskets

2. Verify that the canister is within its service life by inspecting the expiration date on the right side of the canister label.
3. If installed, remove the plug from the side canister connector. Use a quarter or similar item to unscrew the plug. Do not use a screwdriver as it may damage the plug.

4. Remove the canister from its protective poly/foil bag. Remove the plug from the top of the canister and the cap from the threaded end. Discard the cap, plug, and poly/foil bag.

5. Install the two (2) canisters by screwing them into the inlet ports of the blower until snug against the gasket. A Sperian Shower Cap, P/N 769513, may be fitted over the 169001 canister to prevent water from entering the canister. Install shower cap with the inlet at the bottom of the blower. See Figure 8.



Figure 8. Shower Cap Installation

D. Pre-operational Flow Check

 WARNING
<p>Flow check, facepiece fit check, donning, and doffing must be done in a safe, uncontaminated area. Failure to do so may result in personal injury, illness, or death.</p>

The air flow must be verified before each use. Use the following procedure to verify that the blower is supplying adequate air flow.

1. Verify the two (2) canisters are snug against the gaskets.
2. Insert the Flow Meter, P/N 769516, into the blower outlet with the arrow pointing upward as shown in Figure 9.
3. Install the battery pack in the blower assembly and start the blower by flipping the battery ON/OFF switch to ON.

NOTE

- Do not cover the inlet area of the canisters when performing the air flow check.
4. Verify the air flow is greater than 115 liters per minute (4 cfm) by observing that the position of the red ball is at or above the red line on the flowmeter. If the ball is at or above the line on the flowmeter, indicating that the flow exceeds 115 lpm per minute, proceed to the donning section.



Figure 9. Flowmeter Installation



WARNING

If the flowmeter ball is not at or above the line, **DO NOT USE** the blower until the cause can be determined and corrected. Use of a PAPR with low flow may result in personal injury, illness, or death.

5. If the ball is below the line indicating low flow, the most probable causes are:
- One or more canisters plugged. Replace with a new set of canisters.
 - Low battery voltage. Replace with new or recharged battery pack.



WARNING

If changing the canisters and/or the battery pack does not restore normal air flow, **DO NOT USE**. Have the PAPR repaired by the Sperian factory repair center. Using a PAPR that is operating improperly may result in personal injury, illness, or death.

E. Donning



WARNING

• Prior to donning the Sperian PAPR, ensure that the blower gaskets are in place (Figure 7d), and that the gasket is in place in the breathing tube (Figure 10). Use of the PAPR without the



WARNING—Continued

blower gaskets and/or hose assembly gasket in place could allow contaminants to leak into the facepiece, resulting in personal injury, illness, or death.

• Do not connect breathing hose to center port of facepiece. The connection will not provide an adequate seal. Ensure the gasket/valve seat and plug are installed in the center port to provide an adequate seal.

• When the PAPR is used in a contaminated environment, the canister connector gaskets and twin seals must be securely installed as shown in Figure 5. Improperly installed plugs, twin seals, or missing gaskets could allow contaminants to leak into the facepiece, causing personal injury, illness, or death.



Figure 10. Breathing Hose Gasket

- Remove the flow meter from the blower housing.
- Feed the belt through the loops on the blower. Install a battery pack on the blower.
- Visually inspect the female connector on the breathing hose to verify that the grey gasket is installed in the connector. See Figure 10. Attach the breathing hose assembly to the blower by screwing the female connector onto the blower outlet until it is snug against the gasket.
- Secure the belt to your waist and adjust for a snug fit. Secure any excess belt length using retainers on belt. The blower should be positioned at the waistline in the center of the back.
- Verify a plug is securely installed on the facepiece center port and unused side port. Ensure the twin seal (o-ring) is installed under each side port connector by verifying that the o-ring tab is visible. See Figure 11.
- With the breathing tube detached from the facepiece, adjust the top facepiece straps until one inch of strap extends through each buckle. Fully loosen the lower straps.



Figure 11. O-ring and Plugs

7. Place the neck strap (if installed) over your head.

NOTE

If desired, the breathing hose assembly may be attached to the facepiece before donning the facepiece. Perform step 13 to attach the breathing hose before donning the facepiece.

8. Place your chin against the chin cup and center the facepiece on your face.

9. Hold the facepiece against your face and pull the straps over your head.

10. Tighten the two lower straps, temple straps, then the top strap until a good seal is obtained. All straps should lie flat on your head. Do not over-tighten the straps.

11. When properly adjusted, the headstrap hub should be centered on the back of your head and the lower straps should be below your ears.

12. Perform a facepiece fit check as described in this manual.



WARNING

If the breathing hose is not free to move along with the user's body movements, the hose may produce strain on the facepiece which can jeopardize the facepiece seal. The breathing hose assembly must be routed on the user without restriction and clear of potential snagging hazards from other equipment worn by the user. Failure to comply with this warning may lead to personal injury, illness, or death.

13. Route the breathing hose around the same side of the body where the open side port on the facepiece is located. Attach the breathing hose assembly to the facepiece by screwing the 90 degree elbow connector into the open side port on the facepiece until it is snug against the gasket.

14. Turn the blower on by flipping the ON/OFF switch to the ON position.



WARNING

Verify that the blower is providing air to the facepiece before entering a hazardous environment. You should feel air blowing onto your face. Improper air flow may result in inhalation of contaminants. Failure to comply with this warning may lead to personal injury, illness, or death.

15. Verify the blower is providing air to the facepiece by the presence of airflow as felt by the user.

F. How to Select a Facepiece Size

1. Inspect the respirator as described in section VI.B.

2. Install canisters by performing the steps listed in section V.C., "Canister Installation."

3. Don the respirator by performing the steps listed in section V.E., "Donning." Before donning the facepiece, install the Sperian Fit Test Kit, P/N 769095, into the unused side port connector on the facepiece. Do not turn the blower on; leave the ON/OFF switch in the OFF position.

4. Adjust the top three straps until one inch of strap extends through each buckle. Fully loosen the two lower straps.

5. Place your chin in the facepiece chin cup and center the facepiece on your face.

6. Hold the facepiece against your face and pull the straps over your head.

7. Tighten the lower straps, the temple straps, and the top strap until a good seal is obtained. All straps should lie flat on your head. Do not overtighten.

8. When properly adjusted, the headstrap hub should be centered in the crown of your head and the lower straps should be below your ears.

NOTE

Perform a fit check as described in section V.G. before fit testing.



WARNING

If the proper size cannot be determined by performing the following steps, do not wear the respirator. Select a different size. Ask your supervisor or a safety professional for assistance. Failure to comply with this warning may lead to personal injury, illness, or death.

9. Perform a quantitative fit test (QNFT) using a TSI Portacount in accordance with OSHA 1910.134, Appendix A, paragraphs A and C.3. Use the Sperian Fit Test Kit, P/N 769095, to connect the unused side port to the sampling line of the Portacount fit test device .

10. If a minimum fit factor pass level of 500 is not achieved, select a different size facepiece and repeat steps 1 through 8 above. Facepieces are available in three (3) sizes: small, medium, and large. Each facepiece will accept three (3) nose cup sizes (small, medium, and large), with medium as standard. Do not proceed if you cannot achieve a proper fit with any size facepiece and nose cup combination.

G. Fit Check

You must perform the following fit check each time the respirator is worn or before entering the contaminated area.

 WARNING
<p>If a leak-tight seal is not obtained during the following fit check, do not wear the respirator. Ask your supervisor or safety professional for assistance. Failure to comply with this warning may lead to personal injury, illness, or death.</p>

1. Don the respirator by performing the steps listed in section V.E., "Donning". Do not turn the blower on. Leave the ON/OFF switch in the OFF position.
2. Remove the shower caps from the canisters if installed. Using both hands, cover the inlets of the canisters and inhale gently, slightly collapsing the facepiece.
3. Hold your breath for approximately five (5) seconds. The facepiece should remain slightly collapsed. If it does not, readjust the facepiece and fit check again. If a seal is still not achieved, do not wear the respirator. Ask your supervisor or safety professional for assistance.

NOTE

In the event of a decrease or loss of air flow from the blower, the wearer can safely breathe through the blower/filter assembly until reaching an uncontaminated area.

H. Using the Respirator

Before entering the work area for the first time, or re-entering for any reason, you must verify proper operation of the respirator in accordance with paragraph V.D., "Pre-operational Flow Check", and also follow the donning procedures described in paragraph V.E., "Donning".

To receive the maximum protection available from your respirator, you must read, understand, and follow all the warnings, limitations, and instructions contained in this manual and follow your employer's instructions on the use and maintenance of the

respirator. Read and understand the following warnings prior to using the respirator.

 WARNING
<ul style="list-style-type: none"> • The respirator consists of a full facepiece constructed of butyl with a polycarbonate lens, blower, breathing hose assembly, canisters, battery, and a belt. It is the user's responsibility to verify that the respirator materials are acceptable for their intended use. If you are unsure, consult your local safety professional to verify that no possible contaminants and/or liquids will permeate through any of the respirator materials. • Do not don, doff, or store the respirator in an area where contaminants can contact or accumulate inside any component of the respirator. Contaminants inside the facepiece may be inhaled or absorbed upon reuse of the respirator. • Never remove the respirator for any reason while in the work area. • You must leave the work area immediately if the facepiece seal is disturbed for any reason, such as: <ol style="list-style-type: none"> a. Slippage due to sweating or excessive head movement. b. The facepiece becomes dislodged as a result of being knocked. c. Sneezing or coughing while wearing the facepiece. d. You need to blow your nose, scratch your face, or adjust your spectacles. e. For any other reason that would cause the facepiece seal to be disturbed. • You must restore the facepiece-to-face seal and perform a fit check in a non-hazardous environment before reentering the work area. • Failure to comply with this warning may lead to personal injury, illness, or death.

I. Doffing

 WARNING
<ul style="list-style-type: none"> • Exposure to CBRN agents requires proper handling of the respirator after each use and between multiple entries during the same use. • Follow decontamination and disposal procedures after exposure to CBRN agents. • If contaminated with liquid chemical warfare agents, dispose of the respirator after decontamination. • Failure to comply with this warning may result in personal injury, illness, or death.

1. Turn off the blower by flipping the ON/OFF switch to OFF.
2. Loosen the two lower headstraps completely.

3. Grasp the nozzle firmly, and pull the facepiece outward, away from your face.
4. Rotate your head downward and out of the headstraps.
5. Press the tabs inward on the belt buckle to detach the buckle, and remove the blower assembly from your waist.

J. Canister Service Life and Replacement

 WARNING
<ul style="list-style-type: none"> • OSHA allows the use of respirators for protection against contaminants with poor warning properties. You must replace canister when the end-of-service-life indicator (if so equipped) has changed color or in accordance with an OSHA compliant canister change-out schedule that is based on objective information or data that ensures the canister is changed before the end of its service life. • You must immediately leave the contaminated area if you taste or smell contaminants, or if your eyes or throat become irritated. Replace the canister before re-entering the contaminated area. • You must replace the canister when breathing becomes uncomfortable or difficult. As particulates collect on the filter surface, the breathing resistance of the gas mask increases. If you wait too long to replace the canister, particulates may leak past the face seal instead of being collected on the filter; therefore, Sperian recommends that the canister be changed at least daily. • Establishing the canister service life for mixtures of contaminants is a complex task, and one that requires considerable professional judgement to create a reasonable change-out schedule. OSHA provides a "rule-of-thumb" method for determining the canister service life for mixtures. The method addresses two situations. The first is where the individual compounds of the mixture have similar breakthrough times (i.e., within one order of magnitude). In this case, OSHA recommends adding the concentrations of all the components of the mixture to determine a "total concentration," then determine the mixture service life by applying the total concentration to the component with the shortest service life. The second is where the individual compounds have breakthrough times that vary by 2 orders of magnitude or greater. In this case, OSHA recommends the mixture service life be based on the contaminant with the shortest breakthrough time. The OSHA rule-of-thumb methods may not be applicable for all mixtures. In some cases, the actual mixture service life may be much lower than the one calculated.

 WARNING—Continued
<p>For this reason, Sperian recommends that the canister service life for mixtures be determined using experimental methods. If you are unsure how to determine the canister service life for mixtures, please contact Sperian.</p> <ul style="list-style-type: none"> • Do not use the canister in IDLH environments or in areas where the contaminants are unknown. Some contaminants are colorless, odorless, and/or tasteless and provide no indication of exposure. Immediately leave the contaminated area if you taste or smell contaminants, or if your eyes or throat become irritated. Follow decontamination procedures for the incident to which you are responding as established by the IC or ICS. • Failure to comply with this warning may lead to personal injury, illness, or death.

The service life of the canister is addressed in two sections. First, the gas/vapor service life, and second, the particulate filter service life. The canister should always be replaced in accordance with schedules established by regulatory agencies.

Sperian strongly recommends that the canister be discarded after each use. The concentration of contaminants and exposure times are difficult to determine in most gas mask applications. There also could be long periods between uses, and contaminants could desorb from the canister during storage. If the canister is used many times, but for short periods of time, it may be difficult to determine the remaining canister service life, and the canister may not provide the necessary protection in a mission critical situation. The cost of the canister is small compared to the cost of a life if the service life of the canister is exceeded during a critical situation.

1. Gas/Vapor Service Life

The gas/vapor service life depends on the user's breathing rate, the characteristics of the contaminant, and environmental conditions such as temperature and humidity. A saturated canister will leak trace amounts of contaminant to the wearer, which may be detected by odor, taste, and/or irritation. Replace the canister in accordance with an OSHA compliant canister change-out schedule that is based on objective information or data that ensures the canister is changed before its end of service life. Replace the canister earlier if you detect the contaminant by smell, taste, or irritation, or if it shows any signs of damage.

2. Particulate Filter Service Life

The particulate filter service life depends on the user's breathing rate, the characteristics of the contaminant, and environmental conditions such as humidity. The particulate filter used in the canister is NIOSH approved for long duration use against any type of particulate. The canister must be replaced immediately whenever it is damaged,

soiled, soaked with liquids such as water or alcohol, appears to be suspect in any manner, or when the user notices an increase in breathing resistance such that the gas mask becomes uncomfortable to wear. If none of the above occurs and there is a respiratory protection program per OSHA 29 CFR 1910.134 in place, then the canister may be used continually, but only for a maximum of 30 days or 40 hours, whichever comes first. However, the service time can be extended if filter performance to 42 CFR Part 84 can be demonstrated.

Follow applicable decontamination procedures for the incident to which you are responding before replacing the canister.

The respirator should not be used beyond eight (8) hours after initial exposure to chemical warfare agents to avoid possibility of agent permeation. If liquid exposure is encountered, the respirator should not be used for more than two (2) hours. Filter replacement should never be attempted while in a contaminated area or after having been in a contaminated area. You must first consult the IC or ICS having objective information or data on the concentrations of and types of contaminants in the work area and the applicable canister changeout schedule. Follow established decontamination procedures as required before attempting filter replacement. Only use canisters maintained in accordance with section IX, which have been kept in their unopened original foil/poly packaging and cardboard box. Always ensure your replacement filter is within its service life by checking the expiration date which may be found in any one of three locations: on the outside label affixed to the canister storage box, on the label affixed to the upper right hand corner of the poly/foil bag, and on the canister in the far right hand box of the olive colored label. These three locations are depicted in Figures 7a., 7b., and 7c., respectively.



WARNING

- Only install canisters taken from a sealed package.
- Do not replace a canister in a contaminated area or without decontaminating first. Follow procedures established by the IC or ICS for the specific incident to which you are responding.
- Failure to comply with this warning may lead to injury, illness, or death.

Replace the canister as follows:

- a. Return to an uncontaminated area and perform decontamination as required.
- b. Remove the canisters from the blower by turning them counterclockwise. Dispose of the used canisters in accordance with Federal, state, and local laws.

c. Remove new canisters from sealed packages by pulling apart the flaps above the top seam.

d. Install the canister as described in section V.C.

e. Perform a facepiece fit check as described in section V.G.

K. Decontamination

CAUTION

- Do not allow water to enter the blower. If water is allowed to remain in the blower for more than a few minutes, permanent damage will occur. Should water accidentally enter the blower, start the blower and shake the water out. Before storing the PAPR, allow the blower to run for at least ten (10) minutes. Verify that the PAPR is dry.
- To prevent water from entering the blower during decontamination, leave the blower attached to the facepiece, and the filter securely attached to the blower.
- Canisters that have been soaked cannot be used.
- Ensure that water does not enter the blower from inside the facepiece during removal or decontamination.

Decontamination is the removal of toxic substances from equipment and personnel after exposure in a CBRN environment. Proper decontamination prevents contact with residual contaminants on PPE after exposure in a CBRN environment. Various methods are used to remove CBRN contaminants. Decontamination should always be performed prior to doffing PPE and entering clean zones.

After exposure to contaminants, decontaminate your CBRN PAPR and any other PPE prior to removal.



WARNING

- Exposure to CBRN agents requires proper handling of the respirator after each use and between multiple entries during the same use.
- Failure to properly decontaminate may expose you and others in clean areas to harmful CBRN contaminants. Always follow applicable decontamination procedures.
- Failure to comply with this warning may result in personal injury, illness, or death.

Always follow decontamination procedures established by the ICS for the incident to which you are responding. Depending on the length of exposure, contaminants may penetrate into materials and release toxic gases for long periods. Properly dispose of all damaged, toxic, or unusable equipment in accordance with procedures established by the ICS as required by federal, state, and local laws.

- a. Adjust the shower cap on the filter so that the opening is away from the water spray.
- b. Proceed through the shower, following approved decontamination methods.

VI. MAINTENANCE

NOTE

- Inspect this respirator for defects before and after each use, and at least once monthly if not used. Repair as necessary, clean and disinfect after each use, and store properly to assure that the respirator is maintained in satisfactory working condition. Keep a record of inspection and repair dates and results. Refer to the inspection table in the back of this manual.
- Under long-term bulk storage conditions, inspect at least semi-annually. Inspect more frequently if stored in extremes of temperature.

A. Cleaning

Respirators should be cleaned after each day's use by washing with mild soap and warm water. Then disinfect the respirator with a suitable sanitizing solution. OSHA 29 CFR 1910.134, latest edition, and ANSI Z88.2, latest edition, also provide information and guidelines on the cleaning and sanitizing of respirators.



WARNING

- It is the user's responsibility to ensure that the cleaning process chosen provides adequate decontamination and disinfection.
- Specialized processes are required to disinfect and decontaminate a respirator. You must follow the instructions of the manufacturer of the equipment and chemicals.
- In the absence of a commercial sanitizing product, the hypochlorite solution described in the steps below will eliminate many, but not all biohazards.
- Failure to comply with this warning may lead to personal injury, illness, or death.

CAUTION

- **DO NOT** place the battery pack, blower assembly, charger, or charger cord in water or solvents. Damage to the equipment will result.
- Do not use gasoline, organic based solvents, or chlorinated degreasing fluids to clean any part of this respirator.
- Do not clean the facepiece with the blower attached.
- You must ensure that this respirator is not damaged when using disinfecting or decontamination equipment or chemicals.
- The facepiece lens can be scratched through careless or abusive handling. **DO NOT** use abrasive cleaners or pads. Do not towel dry.

NOTE

Silicone and rubber parts of the facepiece may be cleaned between washings with Sperian Mask Wipes, P/N 140096 or 140082.

- a. Make a cleaning solution of warm water and a mild detergent.
- b. Disconnect the breathing tube assembly from the facepiece by unthreading the 90° elbow from the side port connector.
- c. Clean the breathing tube, blower assembly, battery, and battery cord with a brush or damp cloth, then dry with a clean, lint-free cloth. Do not allow water to enter the blower or breathing tube.
- d. Immerse the facepiece top first in the solution until the exhalation valve is covered.
- e. Agitate the facepiece and gently clean with a soft brush.
- f. Thoroughly rinse the facepiece in fresh water, paying particular attention to removal of all soap residue from the exhalation valve. If possible, direct running water onto the exhalation valve.
- g. Disinfect the facepiece in a warm (120°F or 48°C maximum) suitable sanitizing solution such as a "hypochlorite solution" for 2 to 3 minutes. A 50 ppm hypochlorite solution can be prepared by mixing two tablespoons (0.13 ounce) of chlorine bleach per each gallon of water. Rinse thoroughly with fresh warm (120°F or 48°C maximum) water.
- h. Allow the facepiece to drip dry, or dry with a lint-free cloth. Warm air may be used to speed up drying.

NOTE

Washing the lens will remove any user-applied anti-fog coating. Recoat with Sperian Anti-fog Solution, P/N 951015 (1 oz.) or P/N 951016 (16 oz.), or use Sperian single use Anti-fog Wipes, P/N 981803 or dry formulation Anti-fog Wipes, P/N 981808.

i. After cleaning, apply three drops of anti-fog solution (if desired) to the inner surface of the lens and spread it with your finger. Buff with a lint-free cloth. If using an anti-fog wipe, follow the instructions on the wipe packet.

j. Hold the facepiece firmly against your face and exhale several times to ensure that the exhalation valve functions smoothly.

k. Carefully inspect the respirator as described in section VI.B. Reinstall the canisters before use.

CAUTION

If the possibility exists that water may have entered the blower, run the blower for at least 10 minutes afterward to dry the inside. Cartridges and/or filters should remain on the unit whenever the blower is operating in an atmosphere with a high water content.

B. Inspection (See the Inspection Table)

Inspect the respirator before and after each use as described in the inspection table and replace any damaged component. See section VI.C. for repair instructions.

**WARNING**

- Do not attempt to disassemble the blower or battery pack. Disassembly by other than Sperian-certified technicians might render the equipment unsafe or void NIOSH approvals and your warranty.
- Do not use the respirator with damaged or improperly operating valves. Ensure that the twin seal is in the o-ring groove between the lens and connector. Ensure that the part number tab on the o-ring is visible and in the notch provided on the lens.
- Ensure that a gasket is installed at the bottom of each blower threaded inlet port, facepiece side ports, and a gasket/valve seat is installed at the center port with a plug. A plug should also be installed in the unused side port of the facepiece.
- Failure to comply with this warning may lead to personal injury, illness, or death.

C. Repair (See the Repair Table)

Repair by the user is limited to replacement of components listed in this manual and as listed on the NIOSH approval label. Disassembly should be performed only to the extent necessary to replace the components. To protect your warranty and the NIOSH certification of the equipment, all other repairs must be done only by authorized Sperian technicians and repair centers. Consult your Sperian distributor for the one nearest you. You must perform a fit check after any repair and before respirator use.

VII. SHIPMENT

All products returned to Sperian's factory, distributors, or repair centers must be decontaminated prior to shipment.

PRODUCTS CONTAMINATED WITH DANGEROUS SUBSTANCES WILL BE REFUSED AND RETURNED FREIGHT COLLECT.

VIII. OVERHAUL FREQUENCY

This Sperian respirator does not have an overhaul requirement.

IX. STORAGE AND TRANSPORTATION**WARNING**

- The respirator does not have a defined storage life. Carefully inspect the respirator before each use.
- Do not store the respirator in the same container with a used canister. Contaminants in or on the canister may collect on the inside of the respirator and be inhaled the next time the respirator is donned. If a used canister must be reused, store in a separate, sealed container away from the respirator. Ensure that the expiration date on the canister packaging is current.
- Dirt, sweat, hair, saliva, dead skin, and various other materials can collect on the respirator under normal use. If not properly cleaned and sanitized before storage, these materials can promote the growth of harmful bacteria over prolonged storage. Always clean, sanitize, thoroughly dry, and inspect the respirator and components before storage to maintain operational capability for the next use.
- Always maintain minimum package configuration (MPC) whenever using the respirator. Failure to do so will void the NIOSH certification.
- Failure to comply with this warning may lead to personal injury, illness, or death.

CAUTION

- The maximum storage temperature for the gas mask is 140°F (60°C). Long-term storage at elevated temperatures may cause premature deterioration.
- Do not store the blower assembly with the battery pack installed. Always remove the battery from the blower assembly for storage. Store the battery pack and blower away from sunlight, heat, and moisture.

A. Facepiece, Blower, and Breathing Hose Assembly

Always maintain minimum package configuration (MPC) for the application for which your respirator is being used. Failure to do so will void the NIOSH certification. After inspection and cleaning, the respirator should be placed in its Minimum Package Configuration (MPC) (i.e., the facepiece inside the vinyl bag, the zipper closed, and the SC420 blower and breathing hose assembly with caplugs installed). The MPC will protect the respirator under typical storage and transportation conditions. The vinyl storage bag is included with the facepiece. Do not substitute other types of bags.

B. Canister

Canisters exposed to a CBRN environment must be properly decontaminated and discarded after use. Unused canisters should be kept in MPC prior to use (i.e., sealed in the foil/poly packaging and placed inside either the canister cardboard box or the facepiece cardboard box). The facepiece cardboard box will accommodate one canister. The canister may be removed from the box for inspection, but do not remove it from the foil/poly bag until you are ready to use it. Once the canister is removed from the bag, its service life is limited by the applicable canister change-out schedule established by the IC or ICS in the response area.

Minimum Package Configuration

ITEM	PACKAGING
1. Facepiece	In the vinyl storage bag with the zipper closed.
2. Canister	In the original foil/poly bag placed inside cardboard box included with the canister.
3. Blower and Breathing Hose Assembly	Packaging; Caplugs installed on all inlet/outlet ports.
4. LiSO ₂ Non-rechargeable Battery Pack	Original, unopened poly bag OR Placed in cardboard carton, P/N 969584, with lid flap securely closed (maximum of two each battery packs may be placed in closed carton.)
5. NiMH Rechargeable Battery Pack	Original, unopened poly bag OR Placed in cardboard carton, P/N 969584, with lid flap securely closed (maximum of two each battery packs may be placed in closed carton.)
6. Commercial Alkaline D-cell Batteries	Original, unopened commercial blister pack OR Placed in cardboard carton P/N 769584, with lid flap securely closed (maximum of four each D-cell batteries may be placed in closed carton.)
7. Accessories	Assembled to the component and stored as specified above. If the accessory is not physically assembled to components 1, 2, or 3, then there is no MPC requirement.

XI. WARRANTY AND LIMITATION OF LIABILITY

LIMITED WARRANTY: Sperian® warrants this product to be free from defects in materials and workmanship for a minimum of 7 years for the CBRN canister and 1 year for the blower, facepiece, and all other components from the date of purchase. Batteries are excluded from the warranty. During this period, Sperian will repair or replace defective parts, at Sperian's option. Freight charges to and from the Sperian factory shall be paid by the purchaser.

EXCLUSIONS: NOTWITHSTANDING ANY CONTRARY TERM IN THE PURCHASER'S PURCHASE ORDER OR OTHERWISE, THE ONLY WARRANTY EXTENDED BY Sperian IS THE EXPRESSED LIMITED WARRANTY DEFINED ABOVE. THIS WARRANTY IS EXCLUSIVE AND IN LIEU OF ANY IMPLIED WARRANTY OF MERCHANTABILITY, OR FITNESS FOR A PARTICULAR PURPOSE.

CONDITIONS: To maintain this warranty, this product must be used, maintained, and inspected as prescribed in the owner's instruction manual, including prompt replacement or repair of defective parts and such other necessary maintenance and repair as may be required. Normal wear and tear; parts damaged by abuse, misuse, negligence, or accidents; and inhalation and exhalation valves are specifically excluded from this warranty. Exposure to materials that damage or render this product unuseable, such as CBRN agents, will void this warranty. All products returned to Sperian's factory, distributors, or repair centers must be decontaminated prior to shipment. Products contaminated with dangerous substances will be refused and returned freight collect.

LIMITATION OF LIABILITY: No other oral warranties, representations, or guarantees of any kind have been made by Sperian, its distributors, or the agents of either of them, that in any way alter the terms of this warranty. **EXCEPT AS HEREIN PROVIDED, Sperian SHALL HAVE NO LIABILITY FOR ANY LOSS OR DAMAGE, WHETHER DIRECT, INDIRECT, INCIDENTAL, OR CONSEQUENTIAL, TO ANY PURCHASER OR USER OF THIS PRODUCT ARISING FROM THE SALE, USE, OR OPERATION OF THIS PRODUCT.**

**WARNING**

The failure to use and maintain this equipment in strict conformance with the applicable instruction manual may result in personal injury, illness, or death. The equipment's use in any manner that is not expressly authorized pursuant to the applicable instruction manual may result in severe adverse impacts to human health.

XII. REFERENCES

LaTourrette et al. (2003). *Protecting Emergency Responders, Vol 2*, Santa Monica, CA: RAND, ENG-9812731 (available at www.cdc.gov/niosh/docs/2004-144/).

Singe, Dr. Karan (2002). *Bioterrorism: Biological and Chemical Agents Emergency Response Guide*, Neenah, WI: J.J. Keller & Associates, Inc. ([Wwww.jjkeller.com](http://www.jjkeller.com)).

Cocciardi, Joseph A. (2004). *Weapons of Mass Destruction and Terrorism Response Field Guide*, Sudbury, MA: Jones and Bartlett Publishers (www.jbpub.com).

ONLINE RESOURCES

Emergency Personnel Education and Training, *NIMS and Incident command System*, Federal Emergency Management Administration (FEMA), www.fema.gov/tab_education.shtm.

Guidance Documents, *OSHA/NIOSH Personal Protective Equipment Selection Matrix for Emergency Responders*, National Institute for Occupational Safety and Health (NIOSH) www.cdc.gov/niosh/npptl/guidancedocs/

XIII. INSPECTION TABLE

IF ANY OF THE DEFECTS LISTED BELOW ARE FOUND, HAVE THE RESPIRATOR REPAIRED BEFORE USE.

COMPONENT	LOOK FOR
FACEPIECE LENS	<ol style="list-style-type: none"> 1. Nicks, scratches, or abrasions which could impair visibility. 2. Deep gouges or cracks which could reduce impact resistance. 3. Anti-fog coating in need of replacement.
FACEPIECE RIMS	<ol style="list-style-type: none"> 1. Deformed, cracked, or broken. 2. Loose screws. Do not overtighten.
FACEPIECE SKIRT	<ol style="list-style-type: none"> 1. Cuts, gouges, or punctures. 2. Tears or nicks in the sealing area. 3. Deterioration from age, heat, or contamination.
FACEPIECE HEADSTRAP AND BUCKLE STRAPS	<ol style="list-style-type: none"> 1. Abrasions or nicks. 2. Deterioration from age, heat, or contamination.
FACEPIECE BUCKLES	Crushed, bent, broken, or corroded.
FACEPIECE INLET NOZZLE AND NOZZLE ADAPTER	<ol style="list-style-type: none"> 1. Heat or impact damage. 2. Nicks, cracks, tears, or creases in the exhalation valve. Remove the valve cover to inspect the exhalation valve. 3. Nicks, cracks, or dents in the exhalation valve seat. 4. Sticking exhalation valve. Exhale a few times to test. The valve must close after each exhalation. Valves that fail to close must be replaced. 5. Cuts, nicks, abrasions, or excess stretching to the nozzle o-rings.
O-RINGS/TWIN SEALS	Cuts, nicks, abrasions, or excess stretching.
CONNECTORS	<ol style="list-style-type: none"> 1. Cracks, heat, or impact damage. 2. Cuts, nicks, or abrasions on connector sealing flange.
BLOWER	<ol style="list-style-type: none"> 1. Cracked or nicked gasket. 2. Missing gaskets. 3. Loose cover screws. 4. Test for leaks and cracks in the unit by equipping the blower with two (2) canisters, P/N 169001, donning the unit and facepiece, turning on the blower, and passing a fit test ampule, P/N 140098, near the facepiece, breathing tube, and blower. If the wearer detects the banana oil odor, a leak is detected.
BATTERY	<ol style="list-style-type: none"> 1. Connector cracked or broken. 2. Bulging, swelling, torn, cut, or otherwise ruptured outer covering. 3. Liquid under plastic wrap, odor of vinegar or rotten eggs. 4. Loose, cracked, cut, or otherwise damaged alkaline adapter cage or cable.
BELT	<ol style="list-style-type: none"> 1. Webbing color change, fraying, cuts, or nicks. 2. Buckle damaged, cracked, or corroded.
BREATHING TUBE	<ol style="list-style-type: none"> 1. Cuts, nicks, cracks, punctures, or tears that may reduce the level of protection. 2. Age or heat-induced cracking, checking, or hardening. 3. Crushed, broken, or cracked connectors. 4. The tube is securely attached to the connectors and the hose clamps tight with protective shrink tubing over them.

XIII. INSPECTION TABLE—Continued**IF ANY OF THE DEFECTS LISTED BELOW ARE FOUND, HAVE THE RESPIRATOR REPAIRED BEFORE USE.**

COMPONENT	LOOK FOR
MINIMUM PACKAGING FOR FACEPIECE, BREATHING HOSE, BLOWER, CANISTER, AND BATTERIES	1. Tears, holes, or punctures in bags. 2. Tears or holes in cardboard battery cartons.
CANISTER	1. Dents or breaches in canister body. 2. Damaged or missing label that can prevent canister operational use identification.
BATTERIES	1. Dents or cuts in battery casings. 2. Leaks or corrosion of any kind.

XIV. REPAIR TABLE

COMPONENT	INSTRUCTIONS
HEADSTRAP	<ol style="list-style-type: none"> 1. Remove the old headstrap from the facepiece, noting the routing of the straps. 2. Install the new headstrap.
CANISTER CONNECTOR AND TWIN SEAL O-RING REPLACEMENT	<ol style="list-style-type: none"> 1. To remove the canister connector and twin seal o-ring, rotate the connector clockwise. Lift the connector hook and rotate the connector counterclockwise. Pull the connector outward away from the lens. 2. Remove the twin seal o-ring from the groove in the lens. 3. To install, gently separate the o-ring and gasket halves of the new twin seal. A small part number tab should remain attached to each half. Do not use the o-ring if it is damaged. Discard the flat gasket portion. 4. Place the o-ring into the groove on the lens with the part number tab aligned with the slot. 5. Align the three lugs on the underside of the port connector with the three slots in the lens. Insert the connector into the lens port and rotate clockwise. An audible click should be heard. 6. Install a new gasket in the connector. The gasket must be seated at the bottom of the connector. For CBRN models, the gasket must be black not gray. 7. If removed, thread the plug securely into the connector. Do not overtighten. 8. If removed, reinstall inhalation valves on each connector.
NOZZLE COVER	<ol style="list-style-type: none"> 1. To remove, pinch the two lower latches while lifting the lower tab. 2. Disengage the upper hook by lifting the cover upward. 3. To install, engage the cover on the nozzle upper hook. 4. Rotate the cover downward until both lower latches engage the cover. An audible click should be heard.
NOZZLE REPLACEMENT	<ol style="list-style-type: none"> 1. Remove the nozzle cover as described above. 2. Grasp the outside of the lens with both hands and push the nozzle side latches inward and downward with both thumbs. 3. Prior to reinstallation of the nozzle, verify that the nozzle o-ring is free from debris and install the o-ring onto the nozzle. 4. Apply a small amount of Christolube lubricant, Sperian P/N 910452, or equivalent, to the o-ring. 5. Reinstall (if removed) an exhalation valve, nose cup, and gasket/valve seat with inhalation valve. 6. Insert the nozzle into the lens, aligning the top and bottom ribs on the front of the nozzle with the notches in the lens. 7. Push the nozzle inward until both latches engage the lens. An audible click should be heard. 8. Inspect the installed nozzle o-ring for proper installation and seal. If the o-ring appears twisted, pinched, or extruding out of the o-ring groove in the nozzle, remove the nozzle, relubricate the o-ring, and reinstall the nozzle. 9. Install the nozzle cover as described above.

XIV. REPAIR TABLE (Continued)

COMPONENT	INSTRUCTIONS
LENS	<ol style="list-style-type: none"> 1. Remove the canister from the canister connector, if installed. 2. Use a 5/32 inch Allen wrench to remove the two rim screws. 3. Gently separate the rims from the facepiece. 4. Pull the skirt away from the lens. 5. Remove the nozzle and cover as described above. 6. Remove the canister connectors and twin seal o-rings as described above. 7. Install new twin seal o-rings and canister connectors into the new lens as described above. 8. Install the nozzle and cover as described above. 9. Place the lens edge inside the lens channel of the skirt. 10. Align the center of the skirt with the centerline of the lens and knead the skirt until it fits evenly around the lens edge. 11. Lubricate the rims and skirt for assembly by applying a soap and water mixture to the edge of the butyl skirt and the grooves of the rims. 11. Install the rims. Start the screw on one side, then the other. CAUTION: Do not pinch the skirt material between the rims. 12. Alternately tighten each screw until the rim joints are flush against each other. Do not overtighten. 13. Perform a facepiece fit check as described in this manual.
EXHALATION VALVE	<ol style="list-style-type: none"> 1. Remove the nozzle cover as described above. 2. Remove and discard the old exhalation valve. 3. Insert a new valve and pull the valve stem until it snaps into place. 4. Replace the nozzle cover as described above. 5. Perform a facepiece fit check as described in this manual.
BLOWER	<ol style="list-style-type: none"> 1. Remove and discard the old gasket. 2. Install the new gasket. 3. All other repairs must be performed by a Sperian-certified technician.
BATTERY, CHARGER, AND CHARGER CORD	Any repairs to these items must be performed by a Sperian-certified technician.
BELT	Nonrepairable
BREATHING TUBE	Nonrepairable
ACCESSORIES	Each modification kit and accessory purchased from Sperian has installation instructions. Use these instructions for the installation and use of accessories.

XV. ACRONYMS

ANSI	American National Standards Institute
Cap	Canister Capacity; Cap 1 (15 min.), Cap 2 (30 min.), Cap 3 (45 min.)
CBRN	Chemical Biological Radiological Nuclear
COTS	Commercial Off-the-shelf
DHS	Department of Homeland Security
ELSI	End of Service Life Indicator
FEMA	Federal Emergency Management Agency
IC	Incident Commander
ICS	Incident Command System
IDLH	Immediately Dangerous to Life or Health
MIL	Military
MPC	Minimum Package Configuration
MSHA	Mine Safety and Health Administration
NIMS	National Incident Management System
NIOSH	National Institute for Occupational Safety and Health
NPPTL	National Personal Protective Technology Laboratory
OSHA	Occupational Safety and Health Administration
PAPR	Powered Air Purifying Respirator
PPE	Personal Protective Equipment
QLFT	Qualitative Fit Test
QNFT	Quantitative Fit Test
SCBA	Self Contained Breathing Apparatus
TIC	Toxic Industrial Chemical
TIM	Toxic Industrial Material

- [Honeywell Sperian SC420 560002 Powered Respirator](#)
- [Honeywell Sperian SC420 560004 Powered Respirator](#)
- [Honeywell Sperian SC420 560008 Powered Respirator](#)
- [Honeywell Sperian SC420 565092 Powered Respirator](#)
- [Honeywell Sperian SC420 565032 Powered Respirator](#)
- [Honeywell Sperian SC420 565062 Powered Respirator](#)
- [Honeywell Sperian SC420 565762 Powered Respirator](#)
- [Honeywell Sperian SC420 565792 Powered Respirator](#)
- [Honeywell Sperian SC420 565732 Powered Respirator](#)
- [Honeywell Sperian SC420 565034 Powered Respirator](#)
- [Honeywell Sperian SC420 565064 Powered Respirator](#)
- [Honeywell Sperian SC420 565094 Powered Respirator](#)
- [Honeywell Sperian SC420 561032 Powered Respirator](#)
- [Honeywell Sperian SC420 561062 Powered Respirator](#)
- [Honeywell Sperian SC420 561092 Powered Respirator](#)
- [Honeywell Sperian SC420 565764 Powered Respirator](#)
- [Honeywell Sperian SC420 565794 Powered Respirator](#)
- [Honeywell Sperian SC420 565734 Powered Respirator](#)
- [Honeywell Sperian SC420 561792 Powered Respirator](#)
- [Honeywell Sperian SC420 561732 Powered Respirator](#)
- [Honeywell Sperian SC420 561762 Powered Respirator](#)
- [Honeywell Sperian SC420 561064 Powered Respirator](#)
- [Honeywell Sperian SC420 561094 Powered Respirator](#)
- [Honeywell Sperian SC420 561034 Powered Respirator](#)
- [Honeywell Sperian SC420 561734 Powered Respirator](#)
- [Honeywell Sperian SC420 561764 Powered Respirator](#)
- [Honeywell Sperian SC420 561794 Powered Respirator](#)
- [Honeywell Sperian SC420 565038 Powered Respirator](#)
- [Honeywell Sperian SC420 565068 Powered Respirator](#)
- [Honeywell Sperian SC420 565098 Powered Respirator](#)
- [Honeywell Sperian SC420 565738 Powered Respirator](#)
- [Honeywell Sperian SC420 565798 Powered Respirator](#)
- [Honeywell Sperian SC420 565768 Powered Respirator](#)
- [Honeywell Sperian SC420 561098 Powered Respirator](#)
- [Honeywell Sperian SC420 561068 Powered Respirator](#)
- [Honeywell Sperian SC420 561038 Powered Respirator](#)
- [Honeywell Sperian SC420 561738 Powered Respirator](#)
- [Honeywell Sperian SC420 561768 Powered Respirator](#)
- [Honeywell Sperian SC420 561798 Powered Respirator](#)