

CLIMOMASTER™

MODEL 6501series

Multifunction Anemometer

User's Manual

[Kanomax Climomaster 6501-0E Hot-wire Anemometer](#)
[Kanomax Climomaster 6501-AE Hot-wire Anemometer](#)
[Kanomax Climomaster 6501-BE Hot-wire Anemometer](#)
[Kanomax Climomaster 6501-CE Hot-wire Anemometer](#)
[Kanomax Climomaster S-6531-0E Hot-wire Anemometer](#)
[Kanomax Climomaster S-6531-1E Hot-wire Anemometer](#)
[Kanomax Climomaster S-6533-0E Hot-wire Anemometer](#)
[Kanomax Climomaster S-6533-1E Hot-wire Anemometer](#)
[Kanomax Climomaster S-6541-0E Hot-wire Anemometer](#)
[Kanomax Climomaster S-6541-1E Hot-wire Anemometer](#)
[Kanomax Climomaster S-6542-0E Hot-wire Anemometer](#)
[Kanomax Climomaster S-6542-1E Hot-wire Anemometer](#)
[Kanomax Climomaster S-6543-0E Hot-wire Anemometer](#)
[Kanomax Climomaster S-6543-1E Hot-wire Anemometer](#)
[Kanomax Climomaster S-6551-0E Hot-wire Anemometer](#)
[Kanomax Climomaster S-6551-1E Hot-wire Anemometer](#)
[Kanomax Climomaster S-6552-0E Hot-wire Anemometer](#)
[Kanomax Climomaster S-6552-1E Hot-wire Anemometer](#)
[Kanomax Climomaster S-6561-0E Hot-wire Anemometer](#)
[Kanomax Climomaster S-6561-1E Hot-wire Anemometer](#)

List of Components

■ Standard

Items	MODEL	Qty	Functions
Main Body	6501-00	One of these	–
Main Body with analog output	6501-A0		With analog output function
Main Body with pressure sensor	6501-B0		With pressure measurement function
Main body with pressure sensor and analog output	6501-C0		With pressure measurement and analog output functions
Probe	6531-21	One of these	Air velocity, air temperature, humidity sensor (directivity)
	6541-21		Air velocity, air temperature sensor (directivity)
	6542-21		Air velocity, air temperature sensor (needle-type)
	6533-21		Air velocity, air temperature, humidity sensor (spherical)
	6543-21		Air velocity, air temperature sensor (spherical)
	6551-21		Air velocity sensor (mini-spherical, straight type)
	6552-21		Air velocity sensor (mini-spherical, articulating type)
	6561-21		Air velocity, air temperature sensor (directivity)
Probe Cable	6531-06	1	To connect Probe to Main Body
USB Cable	–	1	USB Communication Cable
Carrying Case	–	1	Hard case
Operation Manual	–	1	–
Manganese AA Batteries	–	6	–

■ Available Accessories

Items	MODEL	Functions
Extension Rod (Flexible)	6531-04	For measurements in high places
Extension Rod (Straight)	6531-05	For measurements in high places
AC Adaptor	6113-02	Power Supply
Printer (Recommended)	DPU-S245	To print out data, calculation results, etc.
Printer Cable	6000-31	To connect the Main Body to the Printer
Mobile ANEMOMASTER Measurement Software	6000-41	Data acquisition software
Hands-free Case	6000-61	For hands-free measurement

Important Safety Information

The symbols for the warnings used in this manual are defined below:

Classifications



Danger: To Prevent Serious Injury or Death

Warnings in this classification indicate a danger that may result in serious injury or death if not observed.



Caution: To Prevent Damage to the Product

Warnings in this classification indicate a risk of damage to the product that may void the product warranty if not observed.

Description of Symbols



△ This symbol indicates a condition that requires caution (including danger). The subject of each caution is illustrated inside the triangle (e.g. the high temperature caution symbol is shown on the left).



⊘ This symbol indicates a prohibition. Do not take the prohibited action shown inside or near this symbol (e.g. the disassembly prohibition symbol is shown on the left).



● This symbol indicates a mandatory action. A specific action is given near the symbol.

 **Danger**



Forbidden

Never bring the probe close to a flammable gas atmosphere. The heated sensor may cause a fire or explosion.



Don't touch



Hot surface

Never touch the sensor.

The sensor is heated during operation. Touching the heated sensor may cause burns, and may also damage the sensor itself.



Use properly



Explosive

Do not disassemble or heat the batteries, or put them into a fire.

This may cause burns and the batteries may burst.



Caution

If abnormal noises, smells or smoke occur, or if liquid enters the instrument, turn off the instrument immediately, and remove the batteries or pull out the plug.

There is possibility of malfunction, electric shock, and/or fire. Please contact your local distributor or our service center for repair.

 **Caution**



Use properly



Always unplug the instrument from the electrical outlet when the instrument is not in use.

Failure to do so may cause an electrical shock, fire or circuit damage.



Forbidden

Do not use the instrument in a water vapor atmosphere.

Condensed steam on the sensor will change the heat dissipation rate, resulting in inaccurate measurements. It may also cause damage to the sensor.



Forbidden

This instrument is designed to be used in an environment with a clean air stream without any dust or foreign materials.

Foreign materials may cause damage to the sensor. Also dust or foreign materials on the sensor will impede accurate measurements.



Forbidden

Do not apply force to the sensor.

If the sensor is deformed, the accuracy of the sensor may be affected.



Set up properly

When measuring, ensure that the direction mark is facing into the airflow.

Otherwise, the measurement may be inaccurate, as some sensors (uni-directional probes) have a specific directivity.



Forbidden

Do not use or leave the instrument in a high temperature, high humidity or dusty environment. Do not leave this instrument under direct sunlight for a prolonged period.

The instrument may not function properly out of the specified operating conditions.



Forbidden

Do not subject the instrument or the probe to strong impacts.

Dropping the unit or placing heavy objects on it may cause damage or malfunction to the instrument.



Do not remodel/
disassemble

Never disassemble, modify or repair the product.

Failure to observe the above may cause a short circuit and/or other failures that will affect the performance.



Forbidden

Do not pick up or carry the instrument by the probe cable.

It may cause a malfunction or the wire may break.



Set up properly

Remove the batteries from the battery compartment when storing the instrument for a long period. Do not leave exhausted batteries in the battery compartment. When inserting batteries be sure to insert them with the polarity facing the correct direction.

Failure to do so may cause battery leakage.



Forbidden

Do not wipe the instrument with a volatile solvent.

The body may deform or deteriorate. Use a soft dry cloth to remove stains. If stains persist, soak the cloth in a neutral detergent and wipe the instrument with the soft cloth. Never use volatile solvents such as thinner or benzene.



Forbidden



Electrified

Discharge any built-up static electricity from your body before touching the instrument.

The built-up static electricity may influence the readings and cause damage to the circuit.



Forbidden



Use properly

Regularly check the head of the probe for contamination.

Impurities (such as dust) on the sensor may affect the accuracy of the measurements.

To get rid of dust, use a blow blush for cameras to blow it off, or you can rinse it with water and allow it to air-dry completely.

*Be sure to turn the power off before you clean it.

*Never dry the probe with heat. (Heat may cause permanent damage to the sensor.)



Forbidden

Do not move the main unit and the probe from a cold place to a warm place quickly. It will cause condensation.

Even when used in an environment within the specified operating temperature and humidity, a sudden temperature change may cause condensation. Condensation generated on the sensor may cause inaccurate measurements. Condensation on metal parts may cause rusting and lead to a malfunction.



Forbidden

Do not touch the LCD screen with a sharp-pointed object or with excessive pressure.

It may cause distortion of the screen or a malfunction. Also a rapid temperature change may cause a malfunction of the screen.



Use properly

When storing the instrument, put the instrument in the carrying case and keep it in a place with an ambient temperature of -10 to 50°C and no condensation.



Forbidden

Do not dispose of the instrument as household waste.

Please note that the disposal of the instrument and the batteries should be in line with your local or national legislation. For details, please contact your local distributor.

Table of Contents

§ 1	Part Names and Functions	7
	Main Body	7
	Touch Panel	8
	Probe	9
	Probe Cable	10
§ 2	Getting Started.....	11
	Installing Batteries.....	11
	Connecting the Probe and the Probe Cable	12
	Disconnecting the Probe/Probe Cable.....	12
	Turning ON/OFF the Power	13
	Precautions for Measurements	14
	Duct Shape / Size Input	16
§ 3	Normal Measurement NORMAL MODE	18
§ 4	Measuring Max, Min, and Mean: CALCULATION Mode	22
§ 5	Measurement of Air Flow FLOW RATE Mode	25
	SINGLE FLOW RATE Mode	25
	MULTI FLOW RATE Mode	29
§ 6	Store and Recall Measured Data.....	31
§ 7	Print Out	34
	Preparation for Printing	34
	Print Out in NORMAL Mode	34
	Print Out in CALCULATION Mode and FLOW RATE Mode	35
	Print Out Stored Data (Single Page)	36
	Print Out Stored Data (Plural Pages)	38
§ 8	Digital Output.....	39
	Preparation.....	39
	To Access the CLIMOMASTER from Your PC	39
§ 9	Analog Output	43
§ 10	Other Settings	45
	Date.....	45
	Units and Baud Rate	46
	Settings for LCD Backlight	47
	To Delete Data	48
	To Delete All the Data	49
	Contrast Adjustment	50
§ 11	How to Clean a Probe	51
§ 12	Specification.....	52
§ 13	Principle of Measurement	53
	Principle of Hot-wire Anemometer	53
	What are Discomfort Index (DI) and Dew Point Temperature (DT)?	55
	About Compensation	56
§ 14	Probe Directivity (Air Velocity).....	57
§ 15	Trouble Shooting.....	59
§ 16	Warranty and After Service.....	61
	Kanomax Limited Warranty.....	61
§ 17	Contact Information	62

§ 1 Part Names and Functions

Main Body

- Pressure port is only available on MODEL6501-B0/-C0.

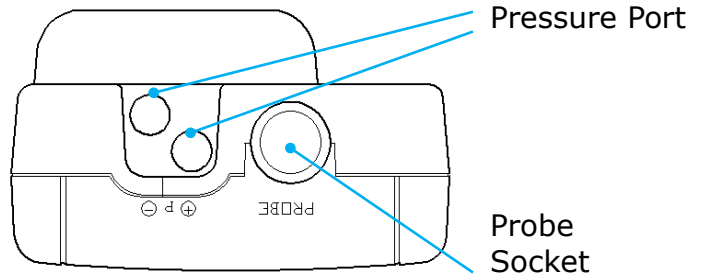

- Analog output is only available on MODEL6501-A0/-C0.

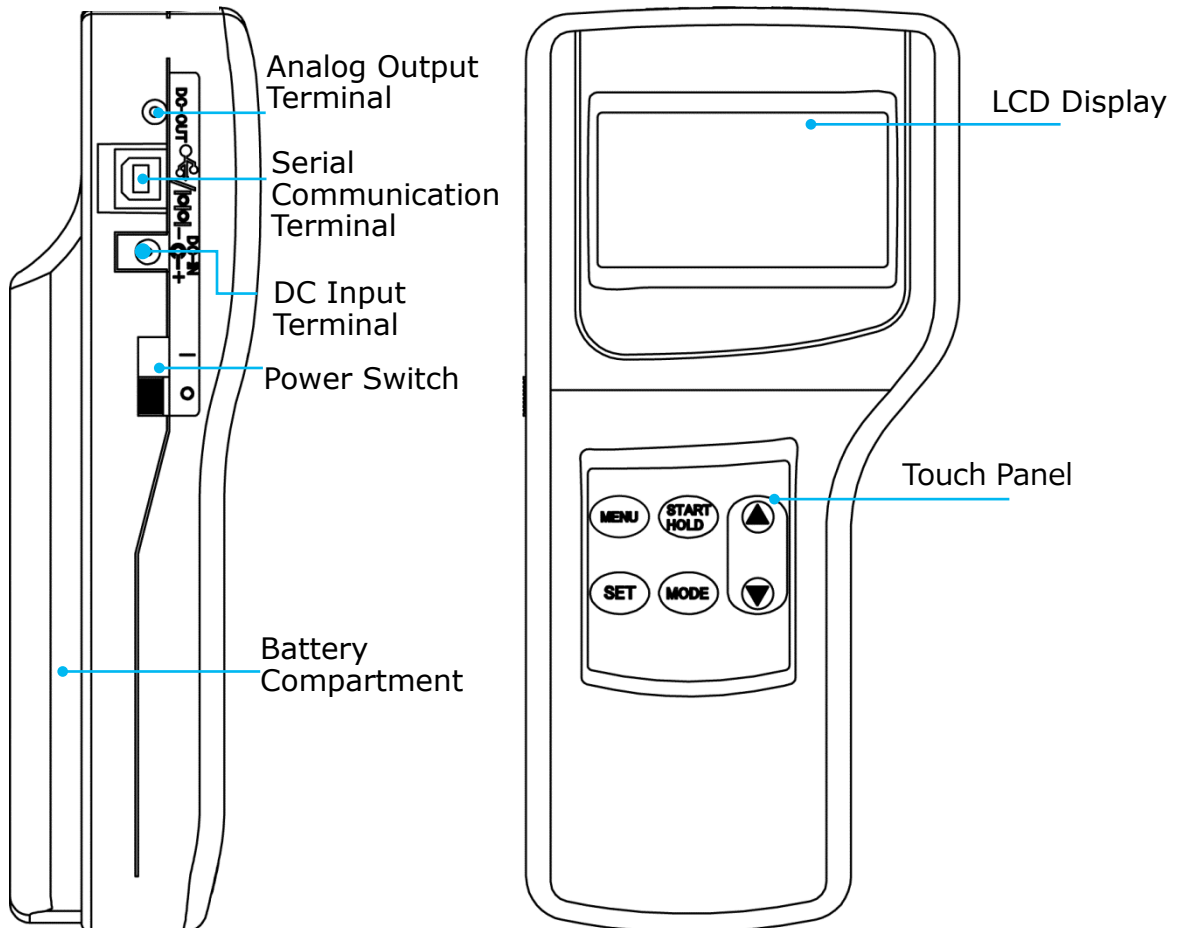

Touch Panel

MENU Key

Enters the Main Menu to select a function.

*Press the MENU Key to CANCEL out of the current measurement or settings and return to the Main Menu.

MENU	1. NORMAL	Normal Measurement Mode
	2. DUCT TYPE	To input duct shape and size
	3. CALCULATION	Calculation Mode
	4. FLOW RATE	To measure flow rate
	5. DATA OUTPUT	To output stored data
	6. DATA CLEAR	To delete stored data
	7. UTILITY	To set the date, time and units
	8. PRESSURE ZERO	Zero point adjustment

■ Zero point adjustment is only available on MODEL6501-B0/-C0.

START/HOLD Key

This key will start and stop the calculation and/or measurement. It also functions as a hold key during measurements.

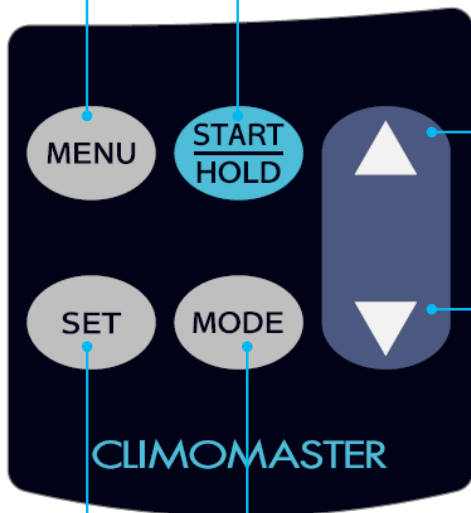

▲ ▼ Navigation Keys

- In Normal Mode, this key allows you to select the time constant (1, 5, or 10 sec) (TC1→TC5→TC10)
 TC1: Displays the instantaneous value at every 1 second
 TC5: Displays the moving average for 5 sec
 TC10: Displays the moving average for 10 sec
- In the Main Menu, press these keys to scroll in the desired direction

MODE Key

You can select the measurement mode

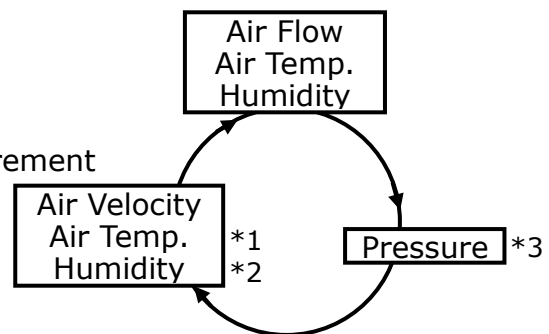

*1 Air temperature is only available on MODEL6531/6541/6542/6543/6533/6561.

*2 Humidity is only available on MODEL6531/6533.

*3 Pressure is only available on MODEL6501-B0/6501-C0

SET Key

Press the key to execute the selected item.

Probe

There are 8 different types of probes available for CLIMOMASTER. The model number and specifications depends on the type of the probe you have. The compatibility feature of the probes allows you to swap out probes freely without having to recalibrate the main unit.

MODEL6542-21

*Unit: mm

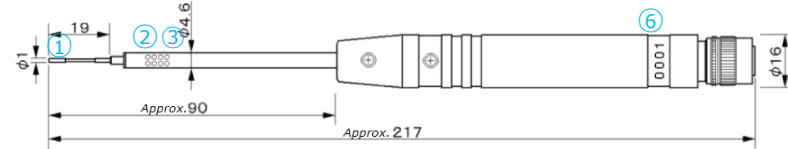

MODEL6531-21/6541-21/6561-21

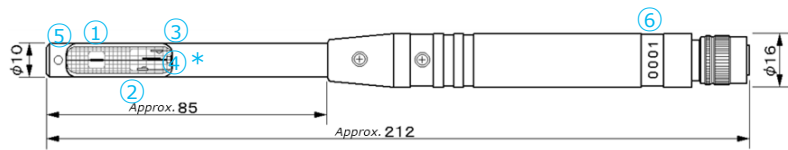

*Model6531 only

MODEL6543-21

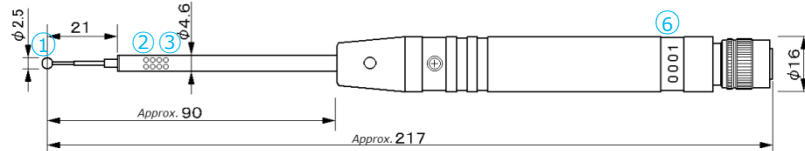

MODEL6533-21

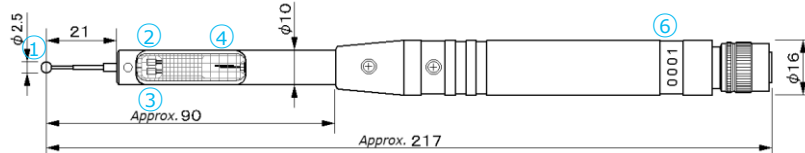

MODEL6551-21

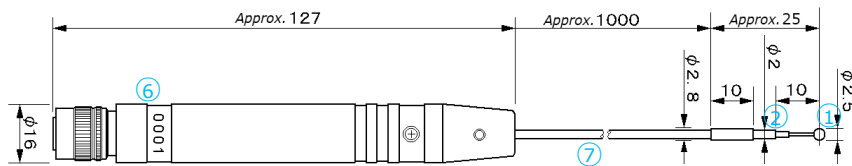

MODEL6552-21

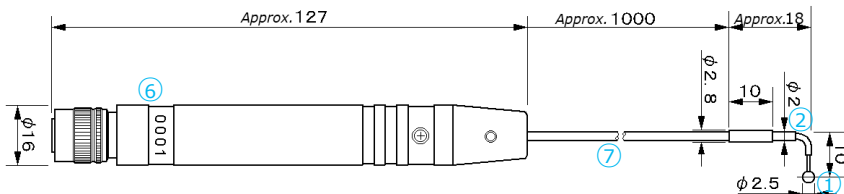

- | | |
|-----------------------|-----------------------------|
| ① Air Velocity Sensor | ② Temp. Compensation Sensor |
| ③ Temperature Sensor | ④ Humidity Sensor |
| ⑤ Wind Direction Mark | ⑥ Probe Number |
| | ⑦ Φ 2 Shielded Cable |

Probe Cable

The probe can be extended by using a probe cable between the main unit and the probe.

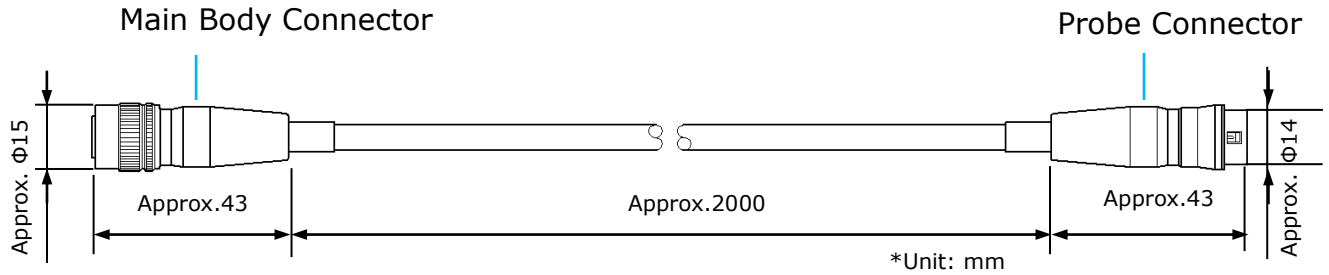

Extension Rod (Optional)

Straight

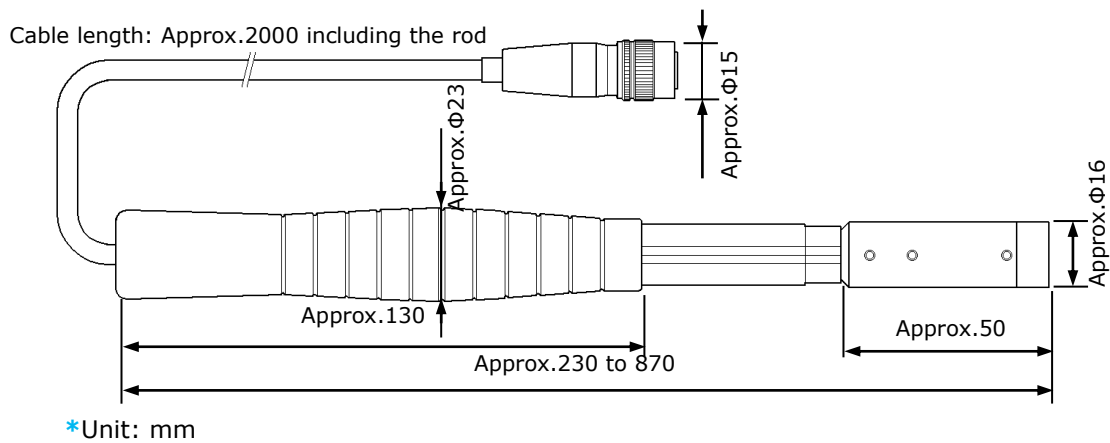

Flexible

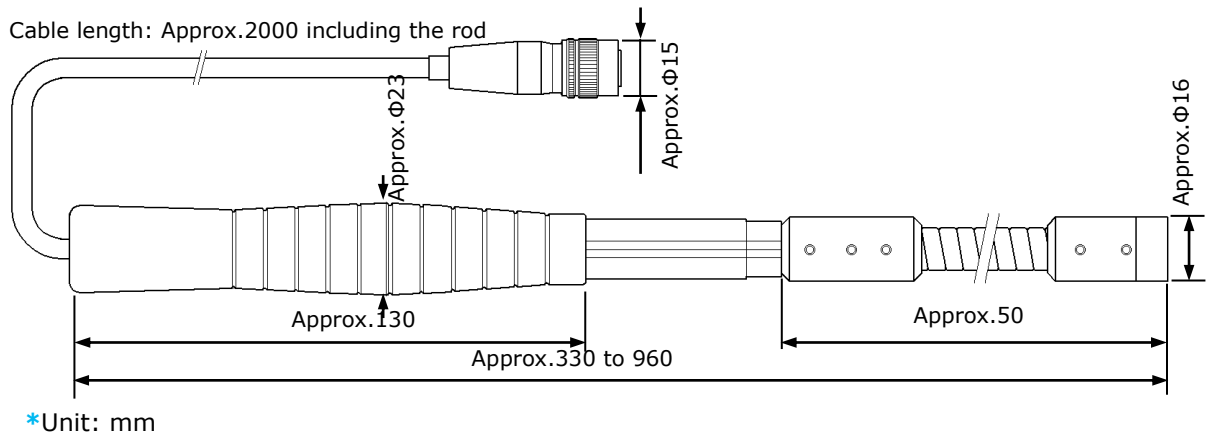

Do not use the Flexible Extension Rod in an environment with an air velocity of 20 m/s or greater; use the Straight Extension Rod for these higher velocities.

§ 2

Getting Started

Installing Batteries

Backside of the body

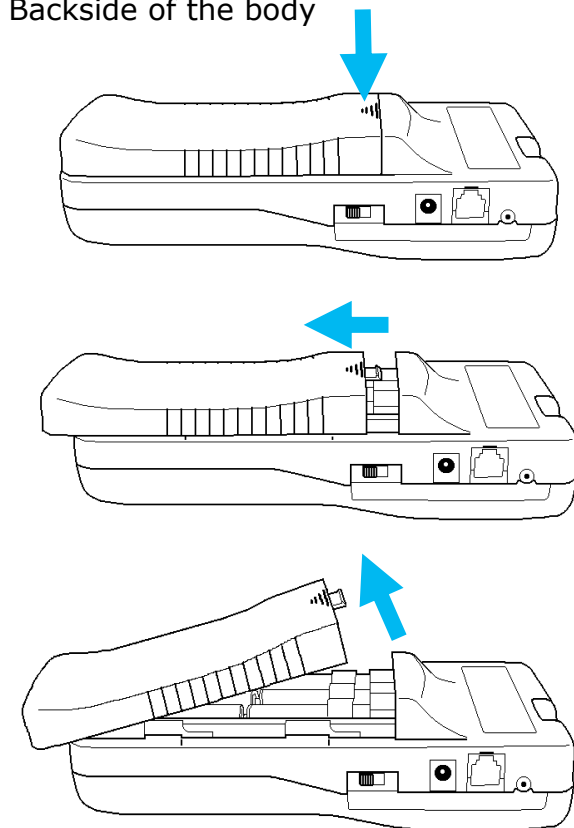

1. Press down on the battery cover.

2. Slide the cover until it stops.

3. Lift the cover away from the body.

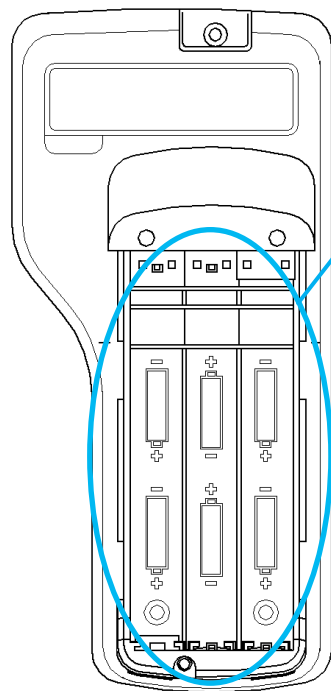

4. Insert the batteries according to the indicated polarity chart. This instrument requires six (6) AA size batteries that must be of the same type. DO NOT mix different types of batteries. Failure to observe this may cause battery leakage or damage the instrument.

*Batteries CANNOT be recharged by the AC adapter.

Types of batteries that can be used are:

- Manganese AA size batteries
- Alkaline AA size batteries
- Ni-Cd AA size batteries
- Ni-MH AA size batteries

5. Put the cover back on by reversing the above procedure.

Connecting the Probe and the Probe Cable

This section describes how to connect the probe or the probe cable to the main unit.

-  Make sure that the power is turned OFF when connecting or disconnecting the probe or the probe cable.

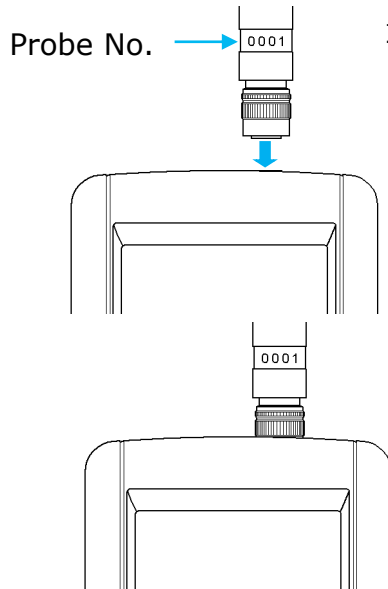

1. Align the connector of the probe or the probe cable with the probe terminal on the body.

*When connecting the probe, make sure the probe number faces towards the front side of the main unit.

2. Line up the connector of the probe and the terminal of the body and gently push until it clicks.

*DO NOT FORCE in the probe/probe cable connector to the main body and DO NOT ROTATE the probe/probe cable once it is connected. Doing so may cause serious damage to the instrument.

Probe Terminal to connect the Probe/Probe Cable

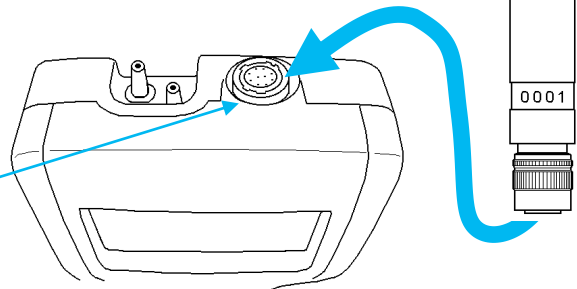

Disconnecting the Probe/Probe Cable

To remove the probe, follow the procedure below:

-  Make sure that the power is turned OFF when connecting or disconnecting the probe or the probe cable.

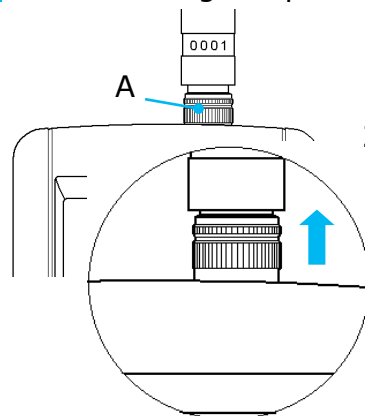

1. Lightly lift the locking ring of the probe/probe cable (A, as shown left).

2. Pull the probe/probe cable out vertically while holding the lock ring up.

*DO NOT rotate the connector of the probe/probe cable when it is connected to the main body. Doing so may cause serious damage to the instrument.

Turning ON/OFF the Power

The power switch to turn the power ON/OFF is located at the side of the instrument. When you turn the power on after connecting the probe/probe cable, a test screen with the Kanomax logo, model, and the version of the firmware will be displayed for a few seconds before it switches to the Normal Mode screen.

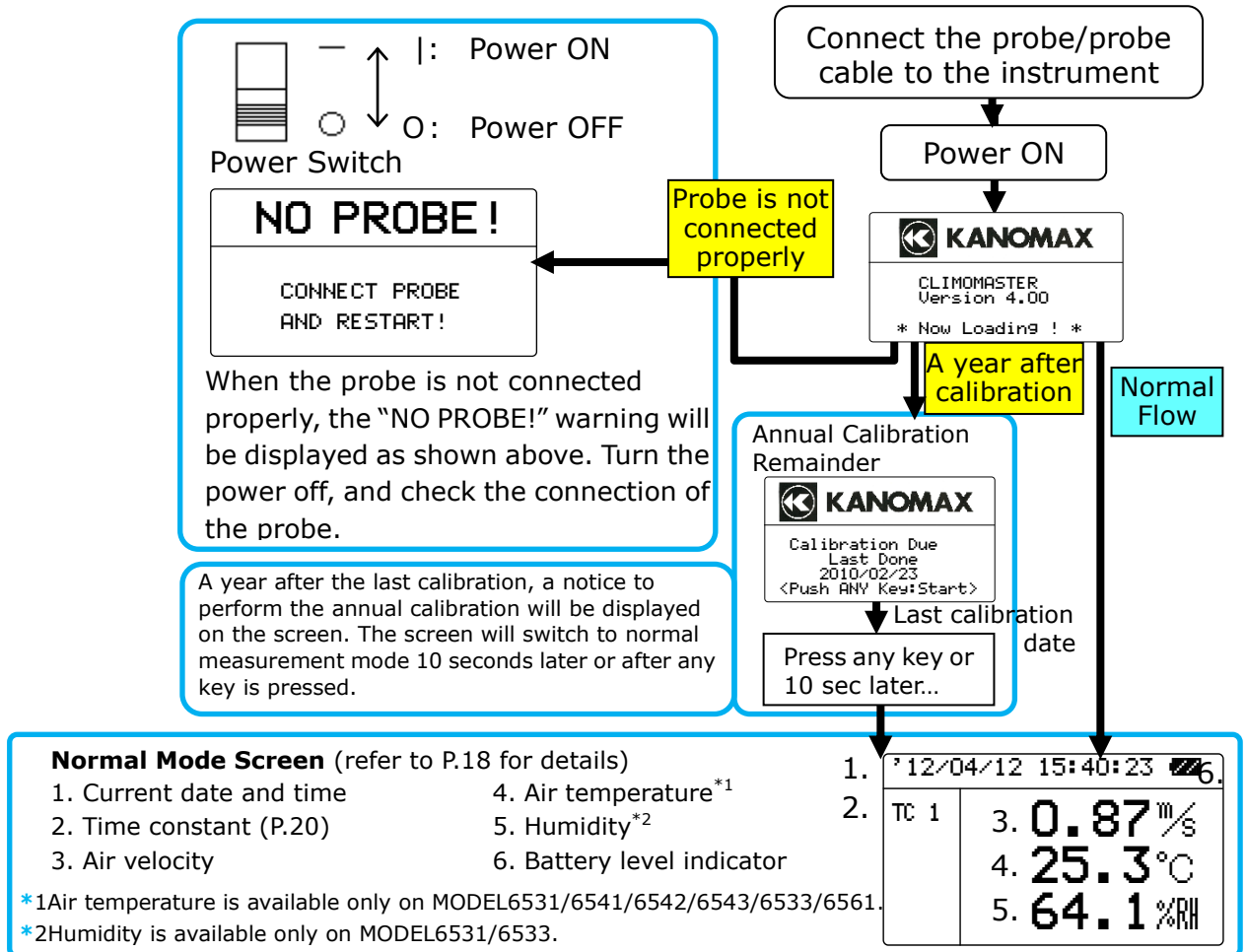

Battery Level Indicator

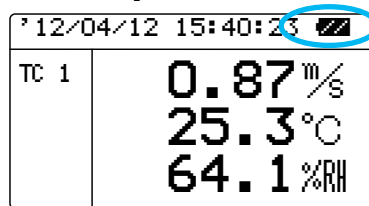

Check the "Battery Level Indicator" to confirm the remaining battery level. The battery consumption rate largely depends on the measured air velocity. When the batteries need to be replaced (or recharged), the indicator will start blinking.

The screen may freeze if a high velocity is measured when the battery level indicator is blinking.

The indicator changes as indicated below according to the remaining battery level:



Locked Status
 - When [X] is displayed, all functions of the instrument will be locked. The current measurement will be cancelled and data will NOT be saved. To release the lock, turn off the power and replace the batteries.

Blinks
 Batteries must be replaced.

Precautions for Measurements

Air Velocity

- MODEL6531/6541/6561: The probe has its own directivity characteristics. Make sure that the direction mark is facing into the airflow. If you are not sure of the airflow direction, slowly rotate the probe and select the point where you get the maximum velocity reading.

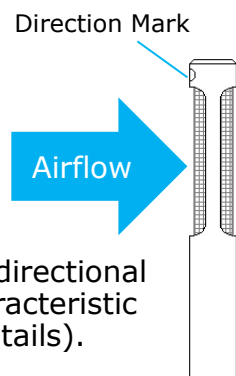

- MODEL6533/6542/6543/6551/6552: This omnidirectional probe has a horizontal, 360 degree dynamic characteristic (Refer to "Directivity of the Probe" on P.57 for details).

- The probe relies on both an air velocity sensor and temperature compensation sensor to accurately measure air velocity. In order to do so, it is necessary that both sensors are evenly exposed to the airflow under the same temperature conditions (Refer to the figures of the probes on P.9 for the location of the sensors).

- For measurements in an environment with rapid air temperature changes, measure for at least 20 seconds and wait for the reading to stabilize before starting the actual measurement (i.e. the data will not be accurate until the probe has time to acclimate to the environment.)

Air Temperature

- The faster the wind, the shorter the response time for temperature measurements. The normal response time is approximately 30 seconds when the air velocity is 1 m/s (90% response). Wait for the reading to become stable before taking a measurement.

- When no airflow is present, the air temperature reading may be higher than the actual temperature due to the heat generated by the air velocity sensor. It is recommended that you SLOWLY wave the probe to create an environment with approx. 0.1m/s airflow to obtain accurate temperature readings.

Humidity

- Humidity readings in an atmosphere with extremely high humidity or rapid temperature changes may be higher than the actual humidity due to condensation generated on the surface of the sensor. If this occurs, allow the probe to dry in an atmosphere with 40%RH humidity or less for 24 hours.

*For more information on proper handling of the ASSMAN Psychrometer, please refer to Japanese Industrial Standard (JIS-Z8806 "Method of measuring Humidity), or its counterpart standards that apply.

— Comparing with ASSMANN Psychrometer —

The humidity measurement function of CLIMOMASTER is strictly calibrated, traceable to Japanese National Standards carried by JEMIC (Japan Electric Meters Inspection Corporation), and it assures you highly accurate performance.

The electronic hygrometer, used in CLIMOMASTER, is known to be more stable and has a shorter response time compared to conventional ASSMANN Psychrometers. Also, the electronic hygrometer is not dependent upon the measurement conditions, while an ASSMANN Psychrometer can easily be influenced by many factors such as dust, condensation and the way the gauze is wrapped.

Pressure

- Pressure sensor is only available on MODEL6501-B0/-C0.

- Do not expose the pressure sensor to more than 75kPa of pressure. Excess pressure may cause serious damage to the sensor.
- The operating temperature must be between 5°C and 40°C or 41°F and 104°F when measuring pressure. The instrument may not operate properly outside of this temperature range.
- Make sure to perform a zero adjustment before measuring pressure. When performing a zero adjustment, leave both pressure ports (+) and (-) open.
- The zero adjustment range is - 0.5 to 0.5 kPa. If the reading is out of this range, an error message will be displayed.

■ Zero Adjustment Procedure

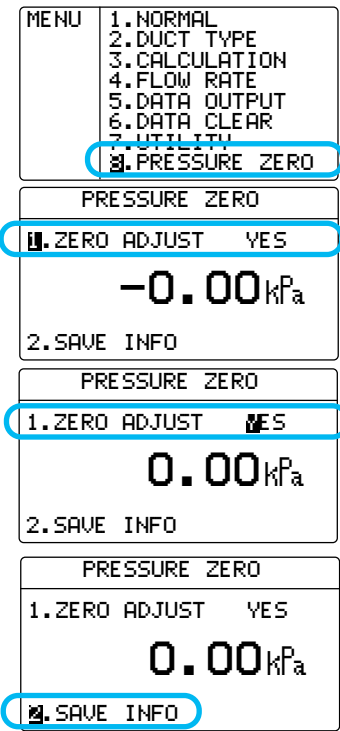

- Press **(MENU)** to enter the Main Menu.
- Use **(▼) (▲)** to select "8. PRESSURE ZERO" and press **(SET)**.
- Use **(▼) (▲)** to select "1. ZERO ADJUST" and press **(SET)**.
- Use **(▼) (▲)** to select "YES". Press **(SET)** to display 0.00 kPa.
- Use **(▼) (▲)** to select "2. SAVE INFO". Press **(SET)**. This will complete the zero adjustment and you are back in Main Menu.

! If you press **(MENU)** before you save, you will go back to the Main Menu without completing the zero adjustment.

■ Connecting the Pressure Tube

*In order to take an accurate measurement, make sure that the tube is properly secured without any leakage, or bends.

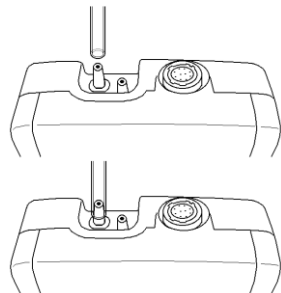

Connect the pressure tube to the (+) or (-) port as you see on the left. Connect/insert the other end of the tube to the measuring hole of the duct. If the pressure that you are going to measure is positive, connect the tube to (+) port. If it is negative, connect the tube to (-) port.

Duct Shape / Size Input

Before measuring the volumetric flow rate, the duct shape and size settings must be entered. Up to 25 different duct types can be registered in this instrument.

Select a duct type from the registered duct types to measure the air flow rate.

MENU	1. NORMAL
	2. DUCT TYPE
	3. CALCULATION
	4. FLOW RATE
	5. DATA OUTPUT
	6. DATA CLEAR
	7. UTILITY
	8. PRESSURE ZERO

Press  to enter the Main Menu.



Use   to select "2. DUCT TYPE".

Press .

<To Set Duct ENTRY No.>



You can choose a memory address from 1 to 25 to store the duct data in.

DUCT TYPE	
1. ENTRY No.	1
2. SHAPE	RECTANGLE
3. W SIZE	-
4. H SIZE	-
5. UNIT(mm/inch)	mm
6. SAVE INFO	

Use   to select "1. ENTRY No." and press .

Use   to select ENTRY No. and press .

<To Set Duct SHAPE (RECTANGLE/CIRCLE)>

Use   to select "2. SHAPE" and press .

Use   to select "RECTANGLE" or "CIRCLE" and press .

DUCT TYPE	
1. ENTRY No.	1
2. SHAPE	RECTANGLE
3. W SIZE	-
4. H SIZE	-
5. UNIT(mm/inch)	mm
6. SAVE INFO	

Rectangular Duct

DUCT TYPE	
1. ENTRY No.	1
2. SHAPE	CIRCLE
3. DIAMETER	300
4. UNIT(mm/inch)	mm
6. SAVE INFO	

Circular Duct

<To Set Duct Size>

Registering a Rectangular Duct

DUCT TYPE	
1. ENTRY No.	1
2. SHAPE	RECTANGLE
3. WIDTH	800
4. HEIGHT	500
5. UNIT (mm/inch)	mm
6. SAVE INFO	

Use to select "3. WIDTH" and press . Use to enter the width and press .

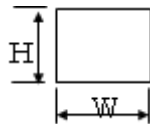

Use to select "4. HEIGHT" and press . Use to enter the height and press .

The maximum is 9999mm or 999.9 inch.

Registering a Circular Duct

DUCT TYPE	
1. ENTRY No.	1
2. SHAPE	CIRCLE
3. DIAMETER	300
4. UNIT (mm/inch)	mm
6. SAVE INFO	

Use to select "3. DIAMETER" and press . Use to enter the diameter of the duct and press . The maximum is 9999mm or 999.9inch.

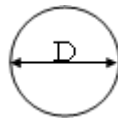

<To Set Units (mm/inch)>

DUCT TYPE	
1. ENTRY No.	1
2. SHAPE	RECTANGLE
3. W SIZE	800
4. H SIZE	500
5. UNIT (mm/inch)	mm
6. SAVE INFO	

Use to select "5. UNIT (mm/inch)" and press .

*For a circular duct, select "4. UNIT (mm/inch)".

Use to select mm or inch and press .

<To Save the Setting>

DUCT TYPE	
1. ENTRY No.	1
2. SHAPE	RECTANGLE
3. W SIZE	800
4. H SIZE	500
5. UNIT (mm/inch)	mm
6. SAVE INFO	



Use to select "6. SAVE INFO" and press .

This will complete the Duct Shape/Size Input and you are back in Main Menu.



If you press before you save, you will go back to the Main Menu without completing the Duct Shape/Size Input.

This is the mode that you will be in, when you first turn on the instrument. In this mode you cannot save any data. The display is updated every 1 second.

To move to NORMAL Mode from another measuring mode, press . Select "1. NORMAL" and press .

MENU	1. NORMAL
	2. DUCT TYPE
	3. CALCULATION
	4. FLOW RATE
	5. DATA OUTPUT
	6. DATA CLEAR
	7. UTILITY
	8. PRESSURE ZERO

Selecting the Measuring Parameters

The measurement parameters can be selected in Normal Mode as described below.

<Air Velocity Measurement Screen>

- Humidity is only available on MODEL6531/6533.
- Air temperature is only available on MODEL6531/6541 /6542/6533/6543/6561
- Pressure is only available on MODEL6501-B0 /-C0.

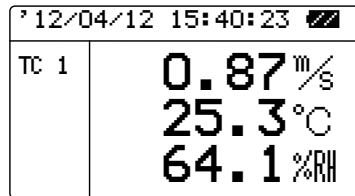

While in Normal Mode as shown left, the measured item can be changed by pressing . The item changes in the following sequence: Pressure→Air Rate→Air Velocity

<Pressure Measurement Screen>

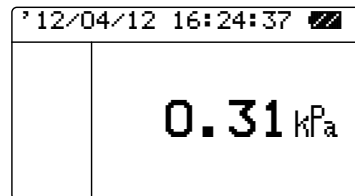

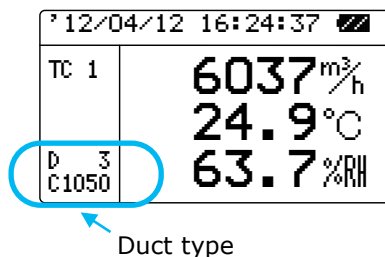

Pressure measurement is a feature for MODEL 6501-B0/6501-C0. This screen is displayed on MODEL 6501-B0/-C0, which has a built-in pressure sensor.

<Flow Rate Measurement Screen>



The selected duct type will be displayed at the lower left of the screen.

To select the duct type, use   while pressing .

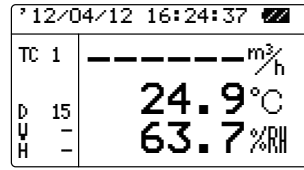

If you have not selected a duct type or your selected duct type (number) is not available, the instrument will not give you the flow rate reading. Make sure the duct type is properly registered and selected. See "Getting Started Duct Shape/Size Input" on P.16 for details.

Hold the Reading

- Humidity is only available on MODEL6531/6533.
- Air temperature is only available on MODEL6531/6541/6542/6533/6543/6561.

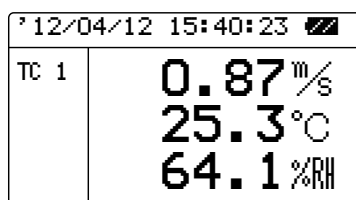

While measuring (in NORMAL Mode), press the  key to hold the current reading. This is applicable in both the flow rate and pressure measurement screens as well.

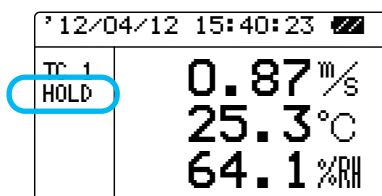



The "HOLD" indicator appears on the display to indicate that the reading shown is held.

Press  again to release.

Hold the Maximum Value

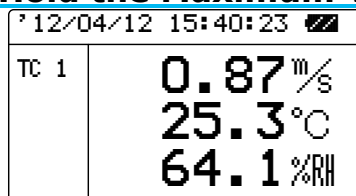

- Pressure is only available on MODEL6501-B0/-C0.

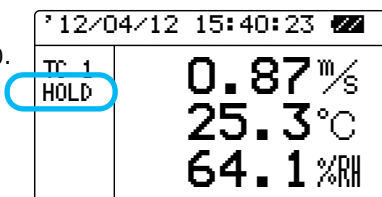

While measuring (NORMAL Mode), press and hold .

The "HOLD" indicator appears on the display. As long as you keep pressing down the  button you can hold the maximum value of each parameter (air velocity, air temperature, humidity and pressure).



When you release , the reading shown will be frozen. Press  again to release.

Setting the Time Constant

- Humidity is only available on MODEL6531/6533.
- Air temperature is only available on MODEL6531/6541 /6542/6533/6543/6561.
- Pressure is only available on MODEL6501-B0/-C0.

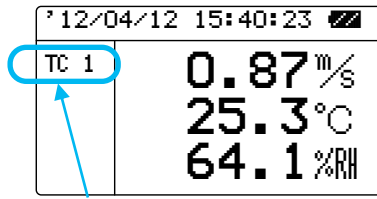

Time Constant

In NORMAL Mode, you can change the Time Constant (TC) by pressing .

You can select the Time Constant from 1, 5 or 10seconds.
 TC1: Displays the instantaneous value at every 1 second
 TC5: Displays moving average for 5 seconds
 TC10: Displays moving average for 10 seconds

*The Time Constant is only effective in Normal Mode. When you first turn on the instrument, it is effective only for the AIR VELOCITY and the AIR FLOW measurements in Normal Mode. If you need to apply the time constant to the AIR TEMPERATURE, HUMIDITY and PRESSURE measurements in Normal Mode, refer to the next section "Changing Time Constant Application".

*** What is Time Constant? ***

Time Constant determines the time span of the moving average. When you set the Time Constant to a larger (longer) value, the readings will become stable. When you select a smaller (shorter) value, the readings will become more responsive and sensitive to changes in air velocity. This function is not available in Calculation or Flow Rate Mode.

MODE	How To Take In Measured Data	EXPLANATION
TC1	<p>0 5 10 15 20 sec. (Measuring Time)</p> <p>Data for 1 sec</p>	Displays the instantaneous value at every 1 sec.
TC5	<p>0 5 10 15 20 sec. (Measuring Time)</p> <p>Average of 5 sec</p>	Updates every second. The value displayed is the average of the past 5 seconds.
TC10	<p>0 5 10 15 20 sec. (Measuring Time)</p> <p>Average of 10 sec</p>	Updates every second. The value displayed is the average of the past 10 seconds.

Changing the Time Constant Application

- Pressure is only available on MODEL6501-B0 /-C0.

When you first turn on the instrument, the Time Constant is only effective for AIR VELOCITY and AIR FLOW in Normal Mode. If you want to make it effective for AIR TEMPERATURE, HUMIDITY and PRESSURE, the following change must be made.

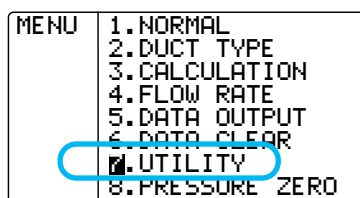

Press to enter the Main Menu.
Use and select "7. UTILITY".
Press .

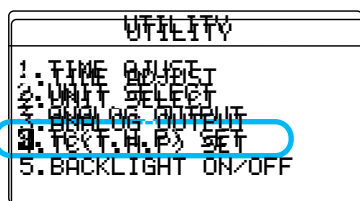

Use and select "4. TC(T.H.P) SET". Press .

*If your instrument does not have the optional pressure sensor, the screen will display "4. TC(T.H)".

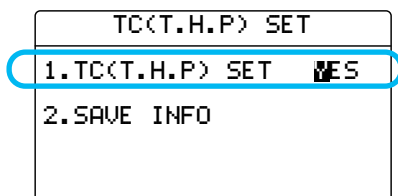

Select "1. TC(T.H.P) SET" and press . Use to select YES or NO.
Press .

YES: The time constant is effective for all parameters in Normal Mode.

NO: The time constant is only effective for the AIR VELOCITY and FLOW RATE.

<Save the Settings>

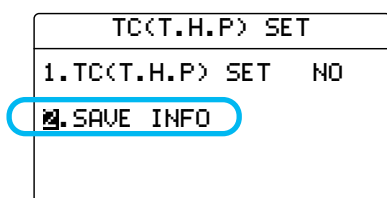

Use to select "2. SAVE INFO".
Press to save the new settings and go back to Main Menu.



If you press before saving the settings you will return back to the Main Menu and any setting changes you made will not be saved.

- *P indicates Pressure (MODEL6501-B0/-C0).
- *T indicates Air Temperature (MODEL6531/6541/6542/6533/6543/6561).
- *H indicates Humidity (MODEL6531/6533).

§ 4

Measuring Max, Min, and Mean: CALCULATION Mode

CALCULATION Mode will automatically calculate the maximum, minimum and mean of the measured data.

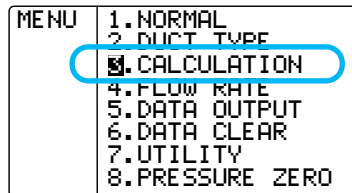
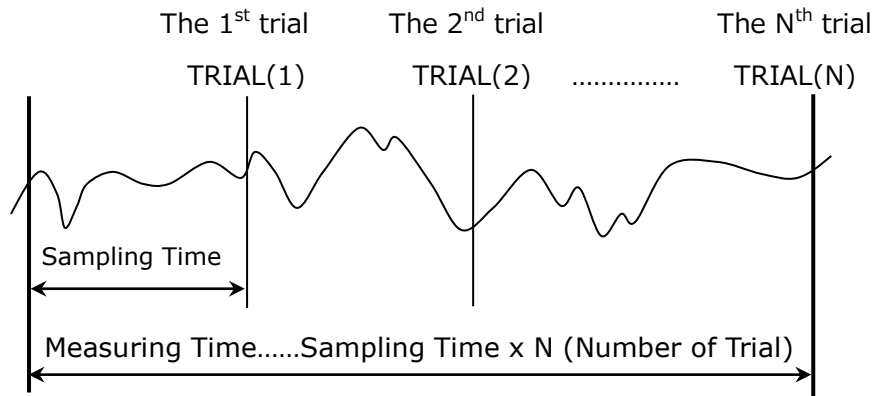

Press (MENU) to enter the Main Menu. Use (▼) (▲) to select "3. CALCULATION" and press (SET).

CALCULATION Mode Display Icons

1. CALCULATION Mode

AVERAGE: Takes a measurement every second and then displays the average for the set sampling time.

INSTANT: Takes a single measurement at the end of the sampling time.

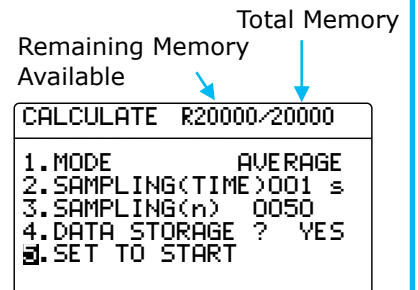

2. SAMPLING TIME (1 to 999 sec)

To set the length of the sampling time.

3. No. TRIAL (N) (1 to 9999 times)

To set the number of samples (trials) needed. Each trial will be for the duration specified in sampling time.

4. DATA STORAGE (YES or NO)

5. SET TO START

Save the settings and return to standby.

<Setting the CALCULATION MODE>

```

CALCULATE R20000/20000
1.MODE          AVERAGE
2.SAMPLING(TIME)001 s
3.SAMPLING(n)  0050
4.DATA STORAGE ? YES
5.SET TO START
  
```

Select "1. MODE" and press **SET**.

Use **▼▲** to select AVERAGE or INSTANT and press **SET**.

<Setting the SAMPLING TIME>

```

CALCULATE R20000/20000
1.MODE          AVERAGE
2.SAMPLING(TIME)001 s
3.SAMPLING(n)  0050
4.DATA STORAGE ? YES
5.SET TO START
  
```

Use **▼▲** to select

"2. SAMPLING (TIME)" and press **SET**.

Use **▼▲** to select SAMPLING TIME (1 to 999 sec) and press **SET**.

<Setting the No. TRIAL (N)>

```

CALCULATE R20000/20000
1.MODE          AVERAGE
2.SAMPLING(TIME)001 s
3.SAMPLING(n)  0050
4.DATA STORAGE ? YES
5.SET TO START
  
```

Use **▼▲** to select "3. SAMPLING(n)" and press **SET**.

Use **▼▲** to select No. TRIAL (1 to 9999 times) and press **SET**.

Data obtained by the number of trials set here will be stored.

<DATA STORAGE>

```

CALCULATE R20000/20000
1.MODE          AVERAGE
2.SAMPLING(TIME)001 s
3.SAMPLING(n)  0050
4.DATA STORAGE ? YES
5.SET TO START
  
```

Use **▼▲** to select

"4. DATA STORAGE?" and press **SET**.

Use **▼▲** to select YES or NO and press **SET**.

There must be sufficient memory to store the calculation data. If the measured data would exceed the available number of empty data locations, Climomaster will automatically adjust the number of trials to match the amount of free remaining memory locations. (Ex.: if there is R0020/20000 remaining, you can only measure 20 times even if you set the No. TRIAL to more than 20.)

<Save the Settings>

```

CALCULATE R20000/20000
1.MODE          AVERAGE
2.SAMPLING(TIME)001 s
3.SAMPLING(n)  0050
4.DATA STORAGE ? YES
5.SET TO START
  
```

Use **▼▲** to select

"5. SET TO START" and press **SET**.

(In the example shown at the left, the instrument will perform fifty (50) measurements of one (1) second intervals.)

<READY>

- Humidity is only available on MODEL6531/6533.
- Air temperature is only available on MODEL6531/6541/6542/6533/6543/6561.
- Pressure is only available on MODEL6501-B0/-C0.

12/04/12 15:40:23	
RDY.	0.87 m/s
N 1	25.3 °C
/ 50	64.1 %RH

The instrument is ready for measuring.

Press **MODE** to change the applied parameters. (Air Velocity, Air Temp, Humidity – Flow Rate, Air Temp, Humidity – Pressure)

Press **START HOLD** to start.

<While Measuring>

12/04/12 15:42:57	
SMP.	2.11 m/s
N 3	25.3 °C
/ 50	64.2 %RH

Press **START HOLD** to stop.

If you have selected "YES" for "4. DATA STORAGE?", the measured data will be stored.

Pressing **MENU** will also stop the measurement but the data will not be saved.

<RESULT>

CALCULATION	
MAX	2.76 m/s
AUG	1.43 m/s
MIN	0.81 m/s

After all the trials are finished, the calculated results will be displayed.

Press **▼▲** to check each parameter in the following sequence: Air Velocity (or Air Flow) → Air Temp. → Humidity → Dew Point Temperature (DT), Discomfort Index (DI).

*If you measured Pressure, only Pressure will be displayed.

Press **START HOLD** to return to the setup menu of the CALCULATION Mode.

Press **MENU** to return to the Main Menu. If YES is selected for "DATA STORAGE", the results will be stored.

Related Functions:

- If a printer is connected, press **MODE** to print out the results.
- To recall stored data → P. 31
- Print out → P.34
- What is Dew Point Temperature (DT) and Discomfort Index (DI)? →P.55

§ 5

Measurement of Air Flow FLOW RATE Mode

CLIMOMASTER features an accurate Flow Rate Mode which corresponds to the industry measurement standards such as ASHRAE.

SINGLE FLOW RATE Mode

This mode is useful for performing a measurement of the airflow of duct (i.e. a duct traverse). Following the steps listed below, you can program Climomaster with the following parameters:

- Sampling Time: The instrument will take a sample at the end of this entered sampling time. Example: if you setup a sampling time of 10 seconds, Climomaster will wait 10 seconds and then take a measurement. If you are taking multiple samples, it will wait 10 seconds between each one before taking the next sample.
- Number of Trials: this is the number of samples you wish to collect from a single point in the traverse.
- Number of Points: this is the total number of points in the traverse.

In single mode, the average, maximum and minimum values from all points will be calculated. The instrument will record the average from each point as well as providing a final average of all the points in the traverse.

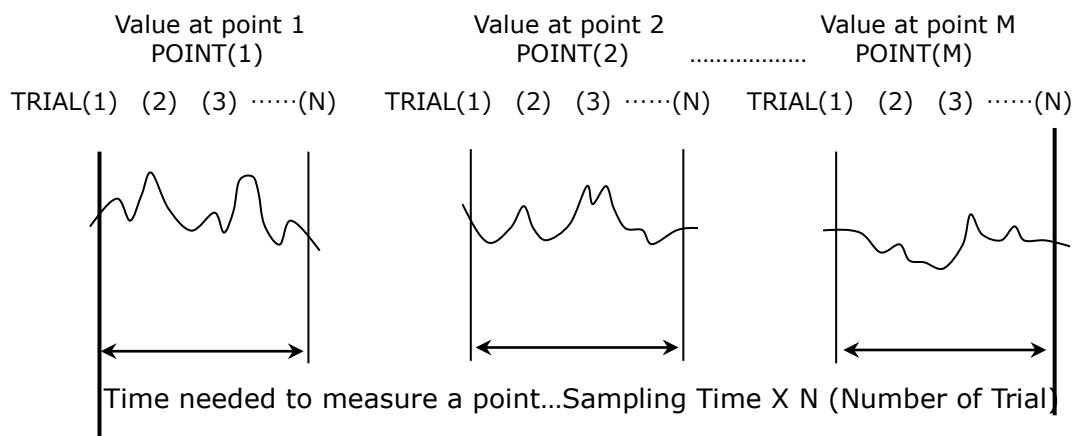

The value of each point is recorded as the average of TRIAL(1) to TRIAL(N). This value (for each individual point) is stored in the memory.

$$\begin{aligned} \text{POINT(1): } & \text{avg(1)} = \Sigma \text{TRIAL(N)} / N \\ \text{POINT(2): } & \text{avg(2)} = \Sigma \text{TRIAL(N)} / N \\ & \vdots \\ \text{POINT(M): } & \text{avg(M)} = \Sigma \text{TRIAL(N)} / N \end{aligned}$$

<Result>

- Average (AVG): $\text{AVG} = (\text{avg}(1) + \text{avg}(2) + \dots + \text{avg}(M)) / M$
- Maximum (MAX): $\text{MAX} = \text{Maximum value from avg}(1) \text{ to avg}(M).$
- Minimum (MIN): $\text{MIN} = \text{Minimum value from avg}(1) \text{ to avg}(M).$

To take an accurate measurement of the airflow of duct, you need to figure out the average velocity of air inside the duct and the area of the cross section of the duct.

Air Flow: Air Volume per Time Unit [m³/min, m³/h, ft³/min, ft³/h]
Air Flow (Q) = Average Air Velocity (U) x Cross Sectional Area (A)

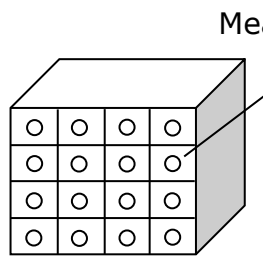

Rectangular Duct

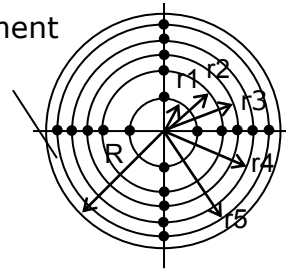

Circular Duct

r1=0.316R
 r2=0.548R
 r3=0.707R
 r4=0.837R
 r5=0.949R

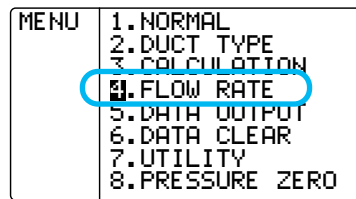

Press **(MENU)** to enter the Main Menu.
 Use **(▼) (▲)** to select
 "4. FLOW RATE" and press **(SET)**.

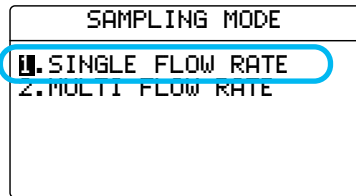

Use **(▼) (▲)** to select
 "1. SINGLE FLOW RATE" and press
(SET).

<Setting the SAMPLING TIME>

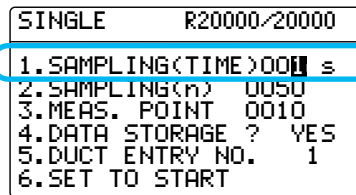

Use **(▼) (▲)** to select
 "1. SAMPLING(TIME)" and press **(SET)**.
 Use **(▼) (▲)** to select SAMPLING TIME
 (1 to 999) and press **(SET)**.

SINGLE FLOW RATE Mode Display Icons

1. SAMPLING TIME (1 to 999 sec)

To set the interval time between each sampling. (INSTANT)

2. No. TRIAL (N) (1 to 9999 times)

To set the number of trials (data) to be sampled at each point.

3. MEAS. POINT (1 to 2000 points)

To set the number of measuring points.

4. DATA STORAGE (YES or NO)

5. DUCT ENTRY NO.

Select the duct entry number of the duct that is to be measured. Registration and changes to the duct information can also be made.

6. SET TO START

Save the settings and return to standby.

Total Memory
 Remaining Memory Available

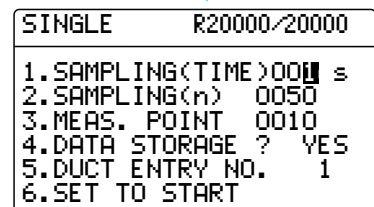

<Setting the No. TRIAL>

```
SINGLE      R20000/20000
1.SAMPLING(TIME)001 s
2.SAMPLING(n) 0050
3.MEAS. POINT 0010
4.DATA STORAGE ? YES
5.DUCT ENTRY NO. 1
6.SET TO START
```

Use to select "2. SAMPLING(n)" and press . Use to select No. TRIAL (1 to 9999) and press .

<Setting MEAS. POINT>

```
SINGLE      R20000/20000
1.SAMPLING(TIME)001 s
2.SAMPLING(n) 0050
3.MEAS. POINT 0010
4.DATA STORAGE ? YES
5.DUCT ENTRY NO. 1
6.SET TO START
```

Use to select "3. MEAS. POINT" and press . Use to select the number of MEAS. POINT (1 to 2000) and press .

<Data Storage>

```
SINGLE      R20000/20000
1.SAMPLING(TIME)001 s
2.SAMPLING(n) 0050
3.MEAS. POINT 0010
4.DATA STORAGE ? YES
5.DUCT ENTRY NO. 1
6.SET TO START
```

Use to select "4. DATA STORAGE?" and press . Use to select YES or NO and press .

<Selecting DUCT ENTRY No.>

```
SINGLE      R20000/20000
1.SAMPLING(TIME)001 s
2.SAMPLING(n) 0050
3.MEAS. POINT 0010
4.DATA STORAGE ? YES
5.DUCT ENTRY NO. 1
6.SET TO START
```

Use to select "5. DUCT ENTRY NO." and press . *If you select an empty ENTRY NO., you cannot start the Flow Rate measurement.

```
DUCT TYPE
1.ENTRY No. 1
2.SHAPE RECTANGLE
3.WIDTH -
4.HEIGHT -
5.UNIT(mm/inch) mm
6.SAVE RETURN
```

The duct type settings screen will be displayed. Here you can input the dimensions of the duct. *Refer to "Duct Shape/Size Input" on P.16 for details.

<Save the Settings>

```
SINGLE      R20000/20000
1.SAMPLING(TIME)001 s
2.SAMPLING(n) 0050
3.MEAS. POINT 0010
4.DATA STORAGE ? YES
5.DUCT ENTRY NO. 1
6.SET TO START
```

Use to select "6. SET TO START" and press .



If you press before saving the settings you will return back to the Main Menu and any setting changes you made will not be saved.

<Ready>

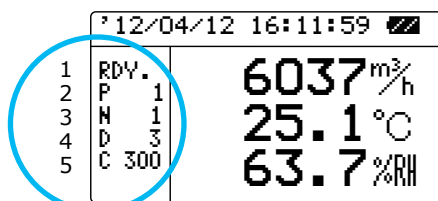

The ready screen will be displayed. Use while pressing to change the entry no. of the duct type. Press to start measuring.

Display Icons

1. RDY: Current Status (READY/SAMPLE)
2. P 1: Current Number of Points
3. N 1: Current Number of Trial
4. D 3: Selected Duct Entry Number
5. C300: Duct Shape and Size
(In this case, the duct is circular and 300mm in diameter.)
For the rectangular duct, W*** and H*** will be displayed.

<While Measuring>

- Humidity is only available on MODEL6531/6533.
- Air temperature is only available on MODEL6531/6541/6542/6533/6543/6561.

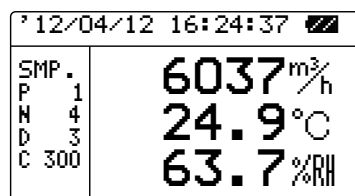

Press to stop the measurement. To continue measuring, press again. Press to complete the measurement. Then the results will be displayed.

If Point 1 is not completed, no results will be displayed on the screen.

Press to complete the measurement without storing data.

<READY After Point 1>

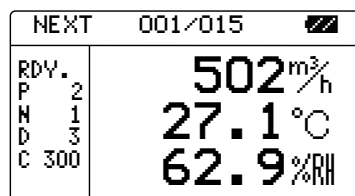

After completing the measurement of Point 1, the instrument will be in STANDBY, ready to measure Point 2.

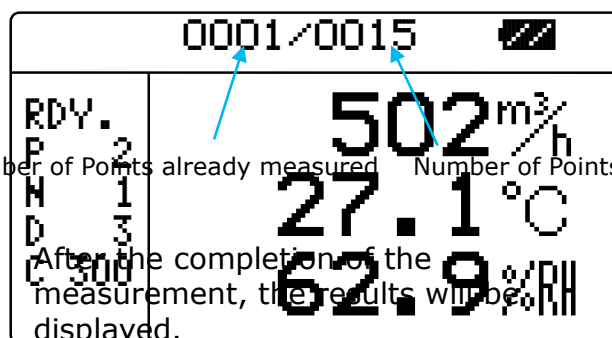

<RESULT>

FLOW RATE	
MAX	106433 m ³ /h
AVG	85134 m ³ /h
MIN	66797 m ³ /h

After the completion of the measurement, the results will be displayed.

Press to select the parameter in the following sequence: **Air Flow**→**Air Temperature**→**Humidity**→**Air Velocity**

Press to return to the Main Menu.

Press to return to the setup screen of the FLOW RATE Mode.

*If "DATA STORAGE" is set to YES, the results will be stored.

MULTI FLOW RATE Mode

MULTI FLOW RATE is very similar to the SINGLE FLOW RATE MODE, except it adds an additional parameter for the number of locations. This allows you to take several air flow measurements (i.e. traverses) and get a total average, for example measuring flow rate from multiple ducts to get an overall average.

The value of each point is the average of TRIAL(1) to TRIAL(N). The value of each location is the average of POINT(1) to POINT(M). The value of each location will be stored in the memory.

$$\begin{aligned} \text{POINT}(1) &: \text{avg}(1) = \Sigma \text{TRIAL}(i) / N \\ \text{POINT}(2) &: \text{avg}(2) = \Sigma \text{TRIAL}(i) / N \\ &\dots \\ \text{POINT}(M) &: \text{avg}(M) = \Sigma \text{TRIAL}(i) / N \end{aligned}$$

$$\begin{aligned} \text{LOCATION}(1) &: \text{AVG}(1) = \Sigma \text{POINT}(i) / M \\ \text{LOCATION}(2) &: \text{AVG}(2) = \Sigma \text{POINT}(i) / M \\ &\dots \\ \text{LOCATION}(L) &: \text{AVG}(L) = \Sigma \text{POINT}(i) / M \end{aligned}$$

<Result>

- Average(AVG): $\text{AVG} = (\text{AVG}(1) + \text{AVG}(2) + \dots + \text{AVG}(L)) / L$
- Maximum(MAX): MAX = Maximum value from AVG(1) to AVG(L)
- Minimum(MIN): MIN = Minimum value from AVG(1) to AVG(L)

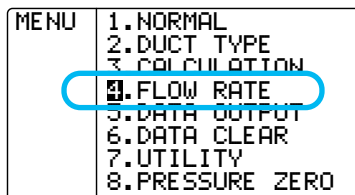

Press **MENU** to enter the Main Menu. Use **▼▲** to select "4. FLOW RATE" and press **SET**.

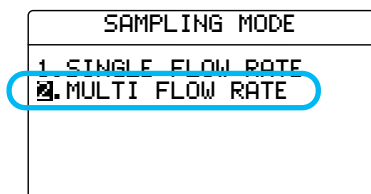

Use **▼▲** to select "2. MULTI FLOW RATE" and press **SET**.

As the same as the SINGLE mode, set the following: 1. Sampling Time, 2. No. Trial, 4. Data Storage, and 5. Duct Entry No.

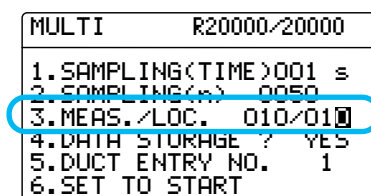

Use **▼▲** to select "3. MEAS./LOC." and press **SET**.

Use **▼▲** to select the number of MEAS. points (1 to 999) and press **SET**. Then use **▼▲** to select the number MEAS. locations (1 to 999) and press **SET**.

<Save the Setting>

MULTI	R20000/20000
1.SAMPLING<TIME>001 s	
2.SAMPLING<n> 0050	
3.MEAS./LOC. 010/010	
4.DATA STORAGE ? YES	
5.DUCT ENTRY NO. 1	
3.SET TO START	

Use to select "6. SET TO START" and press .



If you press before saving the settings you will return back to the Main Menu and any setting changes you made will not be saved.

<Ready>

①	12/04/12 16:11:59	
②	RDY.	502 m ³ /h
③	P 1	
④	N 1	27.1 °C
⑤	L 1	62.9 %RH
	C 300	

The ready screen will be displayed. Use while pressing to change the entry number of the duct type. Press to start measuring. Follow the same procedure as SINGLE mode to measure.

Display Icons

1. RDY: Current Status (READY/SAMPLE)
2. P 1: Current Number of Points
3. N 1: Current Number of Trial
4. L 1: Current Number of Location
5. C300: Duct Shape and Size
(In this case, the duct is circular and 300mm in diameter.)
For the rectangular duct, W*** and H*** will be displayed.

<Display the Results>

FLOW RATE	
MAX	106433 m ³ /h
AUG	85134 m ³ /h
MIN	66797 m ³ /h

After all the measurements at all locations are completed, the calculation results will be displayed. Press to display the results of each item in the following sequence: **Flow rate**→**Air Temp**→**Humidity**→**Air velocity**

Press to print the results, when a printer is connected.

Press to return to the Main Menu.

Press to return to the setup screen of FLOW RATE Mode.

*When "DATA STORAGE" is set to YES, values of each location will be stored.

§ 6

Store and Recall Measured Data

Data which can be stored in the memory of the instrument is shown below.

What can be Stored



MODEL	Measuring Mode	CALCULATION Mode			FLOW RATE Mode	
		V	W	*P	V	W
6531 6533	Display	T H	T H	*P	T H	T H
	Stored Parameters	V T H	V, W T, H	*P	V, W T, H	V, W T, H
6541 6542 6543 6561	Display	V, T	W, T	*P	V, T	W, T
	Stored Parameters	V, T	V W T	*P	V W T	V W T
6551 6552	Display	V	W	*P	V	W
	Stored Parameters	V	V, W	*P	V, W	V, W

V: Air Velocity W: Flow Rate T: Air Temperature H: Humidity
 *P: Pressure is only available on MODEL 6501-B0/6501-C0



To Recall Stored Data

MENU	1.NORMAL 2.DUCT TYPE 3.CALCULATION 4.FLOW RATE 5.DATA OUTPUT 6.DATA CLEAR 7.UTILITY 8.PRESSURE ZERO
------	---

Press  to enter the Main Menu.

Use   to select "5. DATA OUTPUT" and press .



	DATA OUTPUT 1.DISPLAY 2.PRINTER(SINGLE) 3.PRINTER(MULTI)
--	--

Use   to select "1. DISPLAY" and press .

<Setting the PAGE>

CALCULATION

PAGE SET	
PAGE:000
MODE:CALCULATION(A)
DATE:2012/04/12
TIME: 13:40:53
MEAS./LOC.: 20/ -
SHAPE:C -

Use   to select the page that you would like to recall and press .

Page Number
 Measured Mode (CALCULATION (A): AVERAGE/(I): INSTANT)
 Measured Date (Year/Month/Day)
 Measured Time (Hour : Minute : Second)
 Number of Trial
 Duct Shape/Size (For Air Flow Measurement only)

SINGLE FLOW RATE

PAGE SET	
PAGE:000
MODE:SINGLE FLOW RATE
DATE:2012/04/12
TIME: 15:42:53
DATA/DIV.: 3/ 10
SHAPE:C 900

Page Number
 Measured Mode
 Measured Date (Year/Month/Day)
 Measured Time (Hour : Minute : Second)
 Number of Trial/Number of Measuring Point
 Duct Shape/Size

MULTI FLOW RATE

PAGE SET	
PAGE:000
MODE:MULTI FLOW RATE
DATE:2012/04/12
TIME: 15:45:53
MEAS./LOC.: 3/ 10
SHAPE:C 900

Page Number
 Measured Mode
 Measured Date (Year/Month/Day)
 Measured Time (Hour : Minute : Second)
 Number of Trial/Number of Measuring Location
 Duct Shape/Size

<Displaying the Recalled Data>

The recalled data of the selected page will be displayed.

Use   to scroll.

- Humidity is only available on MODEL6531/6533.
- Air temperature is only available on MODEL6531/6541 /6542/6533/6543/6561.
- Pressure is only available on MODEL6501-B0 /-C0.

START:001	END:050		
NUM.	m/s	°C	%RH
001	0.81	25.4	64.7
002	0.95	25.4	64.7
003	0.98	25.6	64.9
004	1.05	25.7	65.1
005	1.21	25.7	65.0
006	0.99	25.9	65.2

Calculation Range
 Data Number, Air Velocity, Air Temperature, Humidity

If you measured Flow Rate in CALCULATION Mode or if you measured in FLOW RATE Mode, you can select Flow Rate or Air Velocity to be displayed by pressing . Only Pressure will be displayed if you measured Pressure.



<Setting the CALCULATION RANGE>



You can select the range of calculation.

If the data range is correct, press  to calculate the range of data displayed on the screen.

START:001	END:050
NUM.	m/s °C %RH
001	0.81 25.4 64.7
002	0.95 25.4 64.7
003	0.98 25.6 64.9
004	1.05 25.7 65.1
005	1.21 25.7 65.0
006	0.99 25.9 65.2

If the range is not correct, press  to display a cursor on "START".

Use   to select the first number of the data (START) that is to be calculated and press .

The cursor will move to "END". Use   to select the number of the last data (END) that is to be calculated and press .

FLOW RATE	
MAX	106433 m ³ /h
AVG	85134 m ³ /h
MIN	66797 m ³ /h

Press  to calculate for the displayed data range.

*You CANNOT set more than one range.

<In FLOW RATE Mode>

Press  to shift the calculation results in the following sequence: Flow Rate→Air Temperature→Humidity→Air Velocity.

<In CALCULATION Mode>

Press  to shift the calculation results in the following sequence: Air Velocity (Flow Rate)→Air Temperature→Humidity→Dew Point Temperature, Discomfort Index.

Press  to return to PAGE SET.

Press  to return to the MAIN MENU.

§ 7

Print Out

Preparation for Printing

Connect the printer cable to the Serial Communication terminal located on the side of the instrument to print out measurement data.

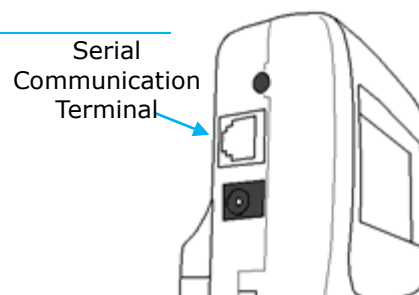

<Requirements>

- Printer (optional).....Recommended: Seiko Instruments Model DPU-S245
- Printer Cable (optional)

<Check the BAUD RATE>

You need to enter the same baud rate and data transmission conditions on both the Main Body and the printer. The factory setting of the Main Body is as follows:

Data Bit Length	8 bits
Parity	None
Baud Rate	Set Value *
Stop Bit	1

*To change the BAUD RATE, refer to "Units and Baud Rate" on P. 46.

*To configure the settings of the printer, refer to the printer operation manual.

<Connecting the Printer>

1. Connect the printer to the Main Body (Serial Communication Terminal) using the printer cable.
2. Turn ON the CLIMOMASTER first, and then turn the printer ON.
3. Make sure that the CLIMOMASTER is displaying NORMAL Mode.

Print Out in NORMAL Mode

- Humidity is only available on MODEL6531/6533.
- Air temperature is only available on MODEL6531/6541/6542/6533/6543/6561.

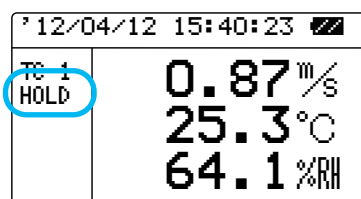

When the screen is displaying in NORMAL Mode, press **START HOLD** to HOLD the display. Press **MODE** to print out the data on the screen.

* If the printer is not connected properly, "PERR" will be displayed in the lower left of the display.

Examples of Print Out

- Pressure is only available on MODEL6501-B0 /-C0.

Air Velocity Mode

2001/06/19 13:42:09	Velocity	0.12 m/s	·Air Velocity
	Temperature	25.9 °C	·Air Temperature
	Humidity	62.7 %RH	·Humidity

Pressure Mode

2001/06/19 13:42:28	Pressure	0.23 kPa
---------------------	----------	----------

Print Out in CALCULATION Mode and FLOW RATE Mode

<Measurement and Calculation Mode (CALCULATION)>

CALCULATION	
MAX	2.76 m/s
AVG	1.43 m/s
MIN	0.81 m/s

Press (MODE) after the measurement and calculation has been performed to print out the result.

<Airflow Measurement Mode (FLOW RATE)>

FLOW RATE	
MAX	106433 m ³ /h
AVG	85134 m ³ /h
MIN	66797 m ³ /h

Press (MODE) after the measurement and calculation has been performed to print out the result.

Examples of Print Out

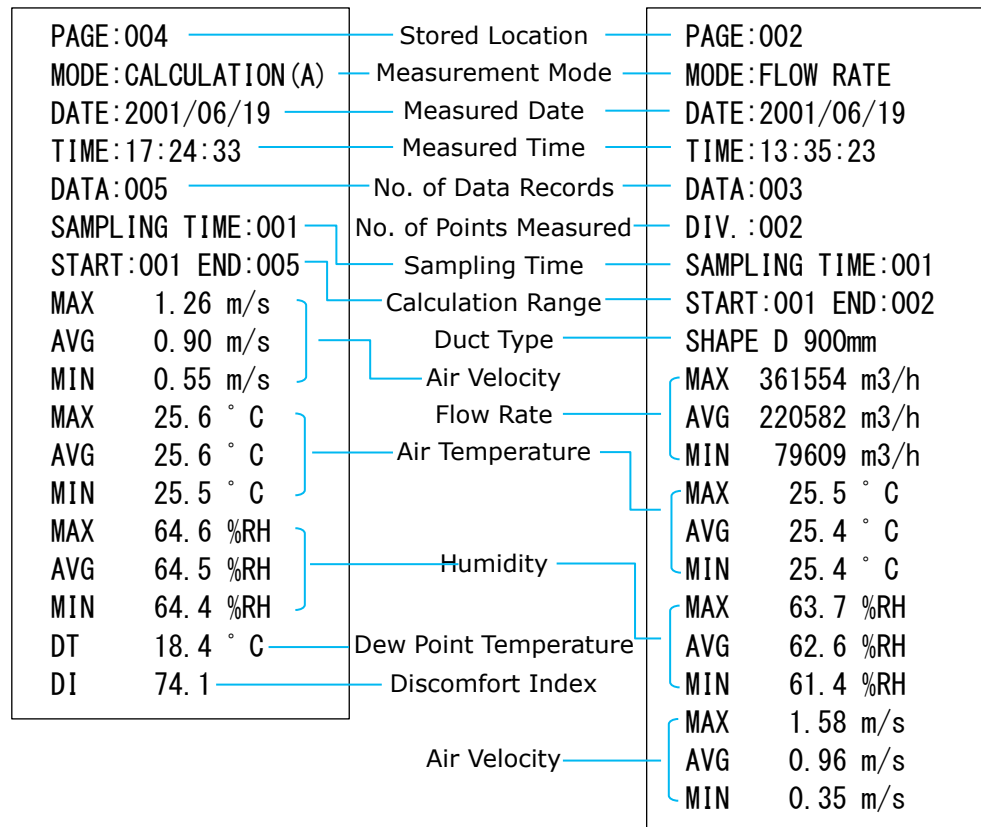

Print Out Stored Data (Single Page)

MENU	1.NORMAL
	2.DUCT TYPE
	3.CALCULATION
	4.FLOW RATE
	5.DATA OUTPUT
	6.DATA CLEAR
	7.UTILITY
	8.PRESSURE ZERO

Press **(MENU)** to enter the Main Menu.

Use **(▼)(▲)** to select "5. DATA OUTPUT" and press **(SET)**.

DATA OUTPUT	
1.DISPLAY	
2.PRINTER(SINGLE)	
3.PRINTER(MULTI)	

Use **(▼)(▲)** to select

"2. PRINTER(SINGLE)" and press **(SET)**.

Use **(▼)(▲)** to select the page that you would to print out and press **(SET)**.

PAGE SET	
PAGE:000	
MODE:SINGLE FLOW RATE	
DATE:2012/04/12	
TIME: 15:42:53	
DATA/DIV.: 3/ 10	
SHAPE:C 900	

Page Number
Measurement Mode (CALCULATION or FLOW RATE)
Measurement Date (Year/Month/Day)
Measured Time (Hour : Minute : Day)
Number of Trial/Number of Measuring Point
Duct Shape/Size (for Air Flow Measurement only)

The data you have selected will be displayed.

START:001	END:050		
NUM.	m/s	°C	%RH
001	0.81	25.4	64.7
002	0.95	25.4	64.7
003	0.98	25.6	64.9
004	1.05	25.7	65.1
005	1.21	25.7	65.0
006	0.99	25.9	65.2

Calculation Range
Data Number, Air Velocity, Air Temperature, Humidity

Press **(▼)** to scroll.

- Humidity is only available on MODEL6531/6533.

- Air temperature is only available on MODEL6531/6541/6542/6533/6543/6561.

- Pressure is only available on MODEL6501-B0/-C0.

If you measured Air Flow in CALCULATION mode or in FLOW RATE mode, you can select Air Flow or Air Velocity to be displayed by pressing **(MODE)**.

*If you measured Pressure, only Pressure will be displayed.

<Setting the range of calculation.>

You can select the range of calculation.

(If you are not going to change the data range, press **(START HOLD)** to calculate all the data.)

- Humidity is only available on MODEL6531/6533.

- Air temperature is only available on MODEL6531/6541/6542/6533/6543/6561.

START:001	END:050		
NUM.	m/s	°C	%RH
001	0.81	25.4	64.7
002	0.95	25.4	64.7
003	0.98	25.6	64.9
004	1.05	25.7	65.1
005	1.21	25.7	65.0
006	0.99	25.9	65.2

Press **(SET)**. Cursor will appear on "START".

Use **(▼)(▲)** to select starting point.

Press **(SET)**. Cursor will move to "END".

You CANNOT set more than one range.

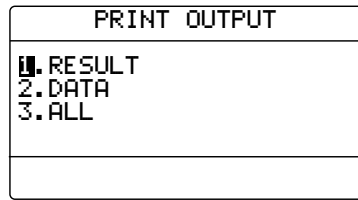

Press to select the contents of the Print Out.

Use to select from items 1 to 3 and press to print out.

Please refer to the printing example shown below.

- | | |
|--------------|---|
| 1. RESULT... | Conditions and Calculation Results |
| 2. DATA..... | Conditions and Stored Data |
| 3. ALL..... | Conditions, Calculation Results and Stored Data |

Example of Print Out

<pre> PAGE SET PAGE:001 MODE:CALCULATION (A) DATE:2001/05/19 TIME:11:32:26 DATA:010 SAMPLING TIME:001 START:001 END:010 MAX 0.75 m/s AVG 0.40 m/s MIN 0.05 m/s MAX 25.8 °C AVG 25.6 °C MIN 25.4 °C MAX 59.1 %RH AVG 58.2 %RH MIN 57.5 %RH DT 16.8 °C DI 73.4 NUM. m/s °C %RH 001 0.05 25.8 57.5 002 0.06 25.8 57.6 003 0.48 25.6 57.7 004 0.48 25.6 57.8 005 0.56 25.6 58.0 006 0.48 25.6 58.3 007 0.39 25.5 58.5 008 0.75 25.5 58.7 009 0.27 25.4 58.8 010 0.46 25.4 59.1 </pre>	<p>Conditions (Always printed out)</p> <p>Calculation Results (RESULT)</p> <p>Measurement Data (DATA)</p>	<pre> PAGE SET PAGE:011 MODE:FLOW RATE DATE:2001/06/21 TIME:16:23:08 DATA:003 DIV.:005 SAMPLING TIME:001 START:001 END:005 SHAPE W 200 H 300mm MAX 32194 m3/h AVG 16871 m3/h MIN 5446 m3/h MAX 25.9 °C AVG 25.9 °C MIN 25.8 °C MAX 72.2 %RH AVG 71.2 %RH MIN 69.7 %RH MAX 1.49 m/s AVG 0.78 m/s MIN 0.25 m/s NUM. m3/h °C %RH 001 20596 25.8 69.7 002 19906 25.9 72.2 003 6214 25.9 71.3 004 5446 25.9 71.4 005 32194 25.9 71.4 </pre>
---	---	--

- Humidity is only available on MODEL6531/6533.
- Air temperature is only available on MODEL6531/6541/6542/6533/6543/6561.
- Pressure is only available on MODE 6051-B0/6051-C0

Print Out Stored Data (Plural Pages)

```
MENU 1.NORMAL
      2.DUCT TYPE
      3.CALCULATION
      4.FLOW RATE
      5.DATA OUTPUT
      6.DATA CLEAR
      7.UTILITY
      8.PRESSURE ZERO
```

Press **MENU** to enter the Main Menu.

Use **▼▲** to select "5. DATA OUTPUT" and press **SET**.

```
DATA OUTPUT
1.DISPLAY
2.PRINTER(SINGLE)
3.PRINTER(MULTI)
```

Use **▼▲** to select

"3. PRINTER(MULTI)" and press **SET**.

```
DATA OUTPUT(MULTI)
1.SELECT START: 0001
          END  : 0003
          SET  : NO
2.ALL DATA      NO
          R00020/20000
```

Use **▼▲** to select

"1.SELECT" and press **SET**.

```
DATA OUTPUT(MULTI)
1.SELECT START: 0001
          END  : 0003
          SET  : NO
2.ALL DATA      NO
          R00020/20000
```

Use **▼▲** to select the starting page.

Press **SET**.

```
DATA OUTPUT(MULTI)
1.SELECT START: 0001
          END  : 0003
          SET  : NO
2.ALL DATA      NO
          R00020/20000
```

Use **▼▲** to select the ending page.

Press **SET**.

```
DATA OUTPUT(MULTI)
1.SELECT START: 0001
          END  : 0003
          SET  : YES
2.ALL DATA      NO
          R00020/20000
```

Use **▼▲** to select "YES" for

selecting the content of the Print Out.

Press **SET**.

```
PRINT OUTPUT
1.RESULT
2.DATA
3.ALL
```

Use **▼▲** to select from items 1 to 3

and press **SET** to print out.

```
DATA OUTPUT(MULTI)
1.SELECT START: 0001
          END  : 0003
          SET  : NO
2.ALL DATA      YES
          R00020/20000
```

Use **▼▲** to select

"2.ALL DATA" and press **SET**, and use

▼▲ to select "YES" for printing out

all pages. Press **SET**.

§ 8

Digital Output

Preparation

You can download the data stored in the CLIMOMASTER to your PC, by connecting the CLIMOMASTER to your PC with the USB cable.

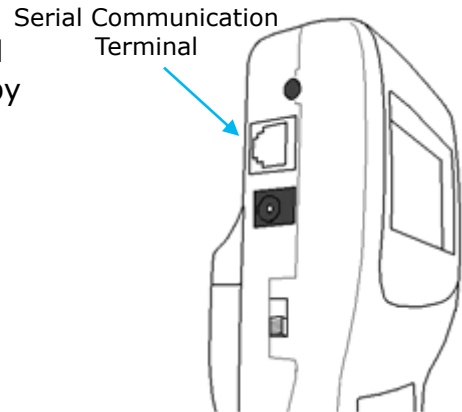

<Requirements>

- Personal Computer
- USB Cable (supplied)
- Communication Software (such as Hyper Terminal for Windows)

<Connecting PC>

1. Connect the PC to the Climomaster using the USB cable.
2. Turn ON the CLIMOMASTER.
3. Make sure that the CLIMOMASTER is displaying NORMAL Mode.

- ◆ Measurement Software for Windows is available. (Optional)

To Access CLIMOMASTER from Your PC

<Icons and their Meaning>

- ␣ : Space
- ↵ : Press Enter
- * : A Number

*All inputs need to be capital letters.

Command	Function
D**** <input type="checkbox"/>	Number of Downloading Data
N <input type="checkbox"/>	Cancel
S <input type="checkbox"/>	Output the Measuring Condition (of On-Time Data)
U <input type="checkbox"/>	Output the Measuring Units
K <input type="checkbox"/>	Output the Duct Shape/Size
P <input type="checkbox"/>	Output the Page Number
T**** <input type="checkbox"/>	Output the Stored Data
M**** <input type="checkbox"/>	Output the Measuring Condition (of Stored Data)
B <input type="checkbox"/>	Output the Measuring Condition of All Pages

Transmission of On-Time Data (Measured at every 1sec)

<Enter the Number of Data Needed>

1. Type "D****".
*Type in the number of data(4 digits) after "D".
2. After "AD", the data will be displayed.
3. Each data represents 1 second of measurement. If you ask for 20 data, it takes approximately 20 seconds to display.
4. The maximum number that can be set is 9999. If you need more, re-send the command

Output Content

- "0000000" will be displayed for humidity on MODEL6541/6542/6543/6561.
- "0000000" will be displayed for temperature and humidity on MODEL6551 and 6552
- Pressure is only available on MODEL6501-B0/-C0.
- Air Velocity Mode: Velocity; Temperature; Humidity
- Humidity Flow Rate Mode: Flow Rate; Temperature; Humidity
- Pressure Mode: 0000000; 0000000; Pressure

```
AD
0.19;26.8;73.4
0.51;26.8;73.5
0.61;27.0;76.1
0.24;27.0;77.5
```

Example: (Air Velocity Mode) typed D0004

<To Cancel>

Type "N".

Example

```
AN
```

<To Download the Measuring Conditions>

1. Type "S".
2. After "AS", the data will be displayed as described below.

Output Content

Measuring Parameter (WTH, VTH or PRS); Time Constant (P.20); Duct Size (Width, Height, Diameter); Units of the Duct Size

- WTH: Flow Rate, Temperature, Humidity
- VTH: Air Velocity, Temperature, Humidity
- PRS: Pressure

Example

```
AS
WTH:01;200;300;---;mm
```

<To Download the Measuring Units>

1. Type "U".
2. After "AU", the data will be displayed.

Example

```
AU
m/s;°C;%RH;kPa;m3/min
```

Output Content

Velocity Unit; Temperature Unit; Humidity Unit; Pressure Unit; Flow Rate Unit

Transmission of Stored Memory

<To Download the Duct Setting>

1. Type "K "
2. After "AK", the data will be displayed.
3. All stored duct settings (1 through 25) will be downloaded.

Example

```
AK
01;200;300;mm
02;500;500;500;inch
24;550;400;mm
```

Output Content

Entry No. (Data Location); Width; Height; Diameter; Units of Duct Size

<To Download the Page Number>

1. Type "P".
2. After "AP", the data will be displayed.
3. Number of data stored pages will be downloaded.

Example

```
AP
P0011
```

<To Download the Stored Data>

1. Type "T**** ".
 - * Type in the desired page number(4 digits) after "T".
2. After "AT", the data will be displayed.

Output Content

- "0000000" will be displayed for humidity on MODEL6541, 6542, 6543 and 6561.
- "0000000" will be displayed for temperature and humidity on MODEL6551 and 6552
- Pressure is only available on MODEL6501-B0/-C0.
- The format of the date output is fixed to Year/Month/Day. This is not affected by date setting of the main body.
- Air Velocity Mode: Number of Data; Velocity; Temperature; Humidity
- Flow Rate Mode: Number of Data; Flow Rate; Temperature; Humidity
- Pressure Mode: Number of Data; 0000000; 0000000; Pressure

- *The data will be displayed in the currently selected units. NOT in the units the data was saved with.
- *Calculated data will not be downloaded.

Example

```
AT
2001/05/19;13:32:28
001;0.05;25.8;57.5
002;0.06;25.8;57.6
003;0.48;25.8;57.7
004;0.48;25.8;57.8
005;0.56;25.8;58.0
```

<To Download the Measuring Condition of Stored Data>

1. Press "M**** ".
*Type in the desired page number(4 digits) after "M".
2. After "AM", the data will be displayed.

Output Content

A. Measuring Parameter

WTH: Flow Rate; Temperature; Humidity
 WT: Flow Rate; Temperature
 VTH: Velocity; Temperature; Humidity
 VT: Velocity; Temperature
 PRS: Pressure

■ Pressure is only available on MODEL6501-B0 /-C0.

B. Measuring Mode

000: Calculation Mode
 001: Flow Rate Mode

C. Sampling Time

D. Number of Data

E. Calculation Mode

AVG: Average
 INS: Instantaneous

In the case of Flow Rate Mode, the number of points is indicated.

F. Width

G. Height

H. Diameter

I. Units of Duct Size

Example

AM
 WTH;000;001;003;AVG;200;300;mm
 A B C D E F G H I

<To Download the Measuring Conditions of All Pages>

1. Press "B ".
2. After "AB", the data will be displayed.

Output Content

*Same as shown above.

Example

AB
 WTH;000;001;AVG;003;200;300;mm
 VTH;001;010;INS;015;150;500;mm
 PRS;000;001;AVG;003;200;300;mm

<Error Message>

Re-type the command.

Example

ED

§ 9

Analog Output

- Analog output is only available on MODEL6501-A0/-C0.

- Data Update.....every 0.1 sec (Except Humidity; updated every 1sec)
- Load Impedance.....Above 5KΩ
- Output Voltage.....DC 0 to 1V

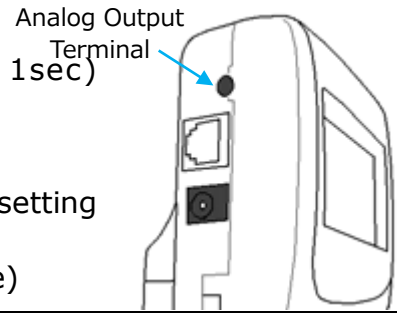

For analog output, you must select one setting from the table below.
(There is no analog output for Flow Rate)

Parameter	Output Range	Conversion Formula (V: voltage)
Velocity (U)	0 to 5 m/s	$U = 5 \times V \text{ m/s}$
	0 to 10 m/s	$U = 10 \times V \text{ m/s}$
	0 to 30 m/s	$U = 30 \times V \text{ m/s}$
	0 to 50 m/s	$U = 50 \times V \text{ m/s}$
	0 to 1000 FPM	$U = 1000 \times V \text{ FPM}$
	0 to 2000 FPM	$U = 2000 \times V \text{ FPM}$
	0 to 6000 FPM	$U = 6000 \times V \text{ FPM}$
	0 to 10000 FPM	$U = 10000 \times V \text{ FPM}$
Humidity (H)	0 to 50 %RH	$H = 50 \times V \text{ %RH}$
	0 to 100 %RH	$H = 100 \times V \text{ %RH}$
Temperature (T)	-20 to 30 °C	$T = 50 \times V - 20 \text{ °C}$
	0 to 50 °C	$T = 50 \times V \text{ °C}$
	0 to 100 °C	$T = 100 \times V \text{ °C}$
	-4 to 86 °F	$T = 90 \times V - 4 \text{ °F}$
	32 to 122 °F	$T = 90 \times V + 32 \text{ °F}$
Pressure (P)	-2 to +2 kPa	$P = 4 \times V - 2 \text{ kPa}$
	-5 to +5 kPa	$P = 10 \times V - 5 \text{ kPa}$

- To change the setting of Time Constant, refer to "To change Time Constant" on P.20.

For the output range, the low end will be set at 0V and the high end will be set at 1V. The voltage is linear.
The Time Constant will be in effect.

Mode	Ways To Take In Measured Data (Analog Output)	Explanation
TC1	<p>Measuring time: 0, 0.5, 1.0, 1.5, 2.0sec</p> <p>Average of 1 sec</p>	Take 10 measurements each second and indicate the average as an instantaneous value at every 1 sec.
TC5	<p>Measuring time: 0, 2.5, 5.0, 7.5, 10sec</p> <p>Average of 5sec</p>	Output the average measured value for 5 seconds at every 0.1 second. Data shifts by 0.1 second.
TC10	<p>Measuring time: 0, 5, 10, 15, 20sec</p> <p>Average of 10sec</p>	Output the average measured value for 10 seconds at every 0.1 second. Data shifts by 0.1 second.

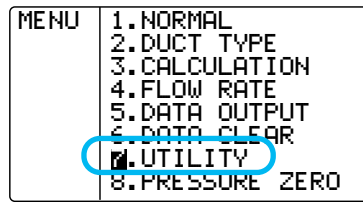

Press to enter the Main Menu.
Use to select "7. UTILITY".
Press .

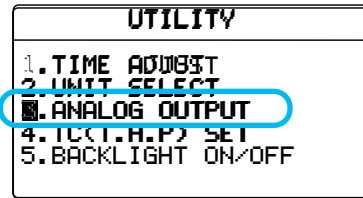

Use to select "3. ANALOG OUTPUT".
Press .

<To Select Data>

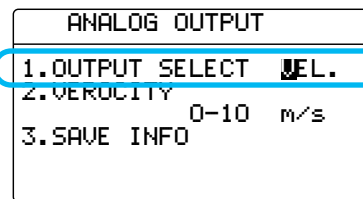

Select "1. OUTPUT SELECT" and press .

- Pressure is only available on MODEL6501-B0 /-C0.
- Humidity is only available on MODEL6531/6533
- Air temperature is only available on MODEL6531/6541 /6542/6533/6543/6561.

Use to select "VEL." (Velocity), "PRS." (*Pressure), "HUM." (*Humidity), or "TMP." (*Temperature).
Press .

<To Set the Output Range>

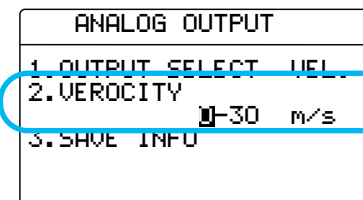

Use to select "2." (selected parameter) and press .

Use to select the range and press .

<To Save the Settings>

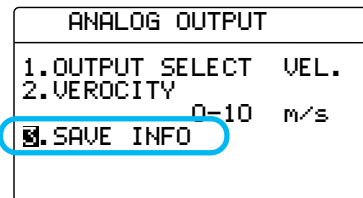

Use to select "3. SAVE INFO".
Press .

If you press before you save, you will return to the Main Menu and the settings will not be saved.

§ 10

Other Settings

Date

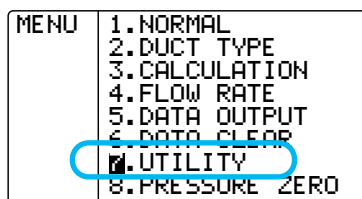

Press .

Use to select "7. UTILITY" and press .

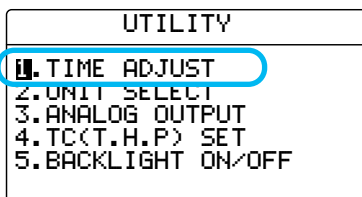

Use to select "1. TIME ADJUST" and press .

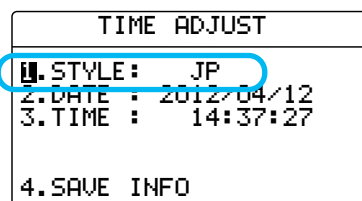

Use to select "1. STYLE" or "2. DATE" and press .

*The style of date displayed on the screen or for printer output depends on this setting, however, the style of the output to digital port is fixed to Japanese style.

- 1. STYLE: Select JP, US or EU
 Japanese style (JP): YYYY/MM/DD
 US style (US): MM/DD/YYYY
 EU style (EU): DD/MM/YYYY
- 2. DATE: Date
- 3. TIME: hour/minute/sec

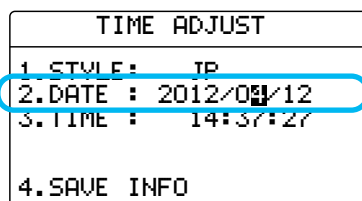

Use to select the desired item.

Use to change the setting.

Press to select the setting and move the cursor back to "1" or "2".

<To Save the Setting>

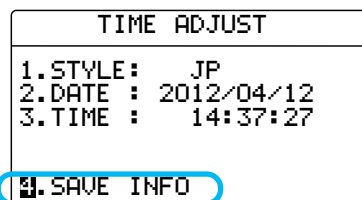

Use to select "4. SAVE INFO" and press to save the change.

The screen returns to the Main Menu.

*When the date is changed, the dates of existing stored measurements will change as well.

If you press before you save, you will return to the Main Menu and the settings will not be saved.

Units and Baud Rate

<Units Conversion Table>	
Velocity	1m/s = 196 FPM
Temperature	T(°F) = 1.8×T(°C) +32
Flow Rate	1m ³ /h = 35.32ft ³ /h

MENU	
1.	NORMAL
2.	DUCT TYPE
3.	CALCULATION
4.	FLOW RATE
5.	DATA OUTPUT
6.	DATA CLEAR
7.	UTILITY
8.	PRESSURE ZERO

Press to enter the Main Menu.
Use to select "7. UTILITY".
Press .

UTILITY	
1.	TIME ADJUST
2.	UNIT SELECT
3.	ANALOG OUTPUT
4.	TC(T.H.P) SET
5.	BACKLIGHT ON/OFF

Use to select "2. UNIT SELECT" and press .

<Units and Baud Rate>

Use to select the desired item (1 through 5). Press .

- Air temperature is only available on MODEL6531/6541/6542/6533/6543/6561.

UNIT SELECT		
1.	VELOCITY	m/s
2.	TEMPERATURE	°C
3.	FLOW RATE	m ³ /h
4.	PRESSURE	kPa
5.	BAUD RATE	19200
6.	SAVE INFO	

.....m/s or FPM for velocity
.....°C or °F for temperature
.....m³/h, m³/min, ft³/min, or ft³/h for flow rate
.....kPa or Pa for pressure
.....4800, 9600, 19200, or 38400 baud rate

- Pressure is only available on MODEL6501-B0/-C0.

UNIT SELECT		
1.	VELOCITY	m/s
2.	TEMPERATURE	°C
3.	FLOW RATE	m ³ /h
4.	PRESSURE	kPa
5.	BAUD RATE	19200
6.	SAVE INFO	

Use to change the setting.
Press .

<To Save the Setting>

UNIT SELECT		
1.	VELOCITY	m/s
2.	TEMPERATURE	°C
3.	FLOW RATE	m ³ /h
4.	PRESSURE	kPa
5.	BAUD RATE	19200
6.	SAVE INFO	

Use to select "6. SAVE INFO" and press . The change will be saved and the screen will return to the Main Menu.

If you press before you save, you will return to the Main Menu and the settings will not be saved.

Settings for LCD Backlight

MENU	1.NORMAL
	2.DUCT TYPE
	3.CALCULATION
	4.FLOW RATE
	5.DATA OUTPUT
	6.DATA CLEAR
	7.UTILITY
	8.PRESSURE ZERO

Press .

Use   to select "7. UTILITY".

Press .

UTILITY	
1.	TIME ADJUST
2.	UNIT SELECT
3.	ANALOG OUTPUT
4.	TCCT.H.P. SET
5.	BACKLIGHT ON/OFF



Use   to select "5. BACKLIGHT ON/OFF".

Press .

LCD BACKLIGHT	
1.	BACKLIGHT ON
FOR	01 min
2.	SAVE INFO

Use   to select "1. BACKLIGHT".

Press .



Use   to select BACKLIGHT ON/OFF. Press .

BACKIGHT OFF : Backlight is always off.

BACKLIGHT ON : If you press any button, the backlight will turn on according to the following settings:

<Settings for Backlight Lit-Up Time>

LCD BACKLIGHT	
1.	BACKLIGHT ON
FOR	01 min
2.	SAVE INFO

Use   and set the amount of time which the backlight will stay on.

ALWAYS: The backlight is always on.

FOR ***: The backlight is on for the specified amount of time (***).



e.g.) FOR 2min: It's on for 2 minutes

<Saving the Change>

LCD BACKLIGHT	
1.	BACKLIGHT ON
FOR	01 min
2.	SAVE INFO

Use   and select " 6 . SAVE INFO"

Press .

 If you press  before you save, you will return to the Main Menu and the settings will not be saved.

To Delete Data

Press **MENU** to enter the Main Menu.

MENU	1.NORMAL
	2.DUCT TYPE
	3.CALCULATION
	4.FLOW RATE
	5.DATA OUTPUT
	6.DATA CLEAR
	7.UTILITY
	8.PRESSURE ZERO

Use **▼▲** to select "6. DATA CLEAR" and press **SET**.

Use **▼▲** to select "1. CLEAR" (delete the selected data only) and press **SET**.

DATA CLEAR	
1.CLEAR	START: 0001
	END : 0001
	SET : YES
2.ALL CLEAR	NO
R19950/20000	

Starting Page Number
Ending Page Number
Partial Delete (YES or NO)
All Delete (YES or NO)
Remaining Memory / Total Memory
(The number of sampling data that can be stored)

DATA CLEAR	
1.CLEAR	START: 000 1
	END : 0001
	SET : YES
2.ALL CLEAR	NO
R19950/20000	

Use **▼▲** to select the starting page. Press **SET**.

DATA CLEAR	
1.CLEAR	START: 0001
	END : 000 2
	SET : YES
2.ALL CLEAR	NO
R19950/20000	

Use **▼▲** to select the ending page. Press **SET**.

DATA CLEAR	
1.CLEAR	START: 0001
	END : 0002
	SET : YES
2.ALL CLEAR	NO
R19950/20000	

Use **▼▲** to select "YES" for partial delete. Press **SET**.

The selected page will be deleted and the remaining data will shift up. (See diagram below)

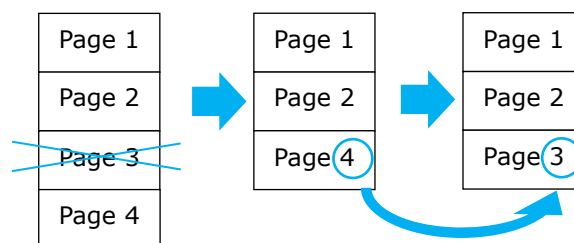

Page Number will change automatically



To Delete All the Data

Press  to enter the Main Menu.

MENU	1.NORMAL
	2.DUCT TYPE
	3.CALCULATION
	4.FLOW RATE
	5.DATA OUTPUT
	6.DATA CLEAR
	7.UTILITY
	8.PRESSURE ZERO

Use   to select "6. DATA CLEAR".

Press .

Use   to select "2. ALL CLEAR". Press .

DATA CLEAR	
1.CLEAR START:	0001
END :	0001
SET :	NO
2.ALL CLEAR	NO
.....All Delete (YES or NO)	
R19950/20000Remaining Memory / Total Memory (The number of sampling data that can be stored)

DATA CLEAR	
1.CLEAR START:	0001
END :	0001
SET :	NO
2.ALL CLEAR	YES
R19950/20000	

Use   to select "YES" to delete.

Press .

DATA CLEAR	
1.CLEAR START:	0001
END :	0001
SET :	NO
2.ALL CLEAR	YES
R20000/20000	

All the data will be deleted and the Remaining Memory will be 20000.

Contrast Adjustment

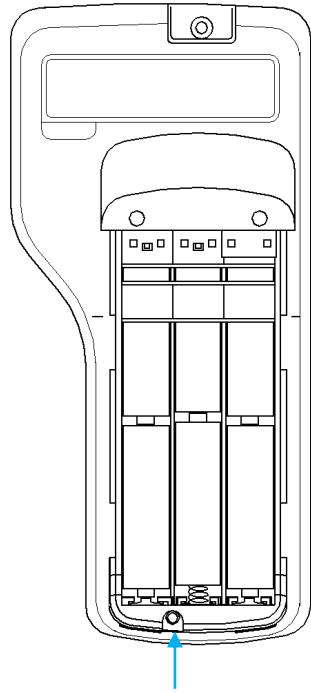

Contrast Adjusting Dial

If the LCD display of the CLIMOMASTER is too dark or too light, there is an adjustment dial at the back, bottom of the unit, inside the battery cover.

You can adjust the contrast by using a precision screwdriver (-) (0.9 to 1.5mm) .
Turn the dial clockwise to darken the LCD and counterclockwise to lighten it.

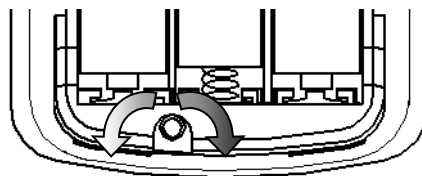

Lightens Darkens

Dust or particles attached to the velocity sensor would alter the amount of heat diffusion, which leads to a less precise reading. Also, deformation or clogging of the protective mesh around the sensor of the probe would also affect the accuracy of the instrument. Users are encouraged to clean the probe regularly to maintain the accuracy of measurements.

Procedure

Clean the sensor by soaking it in water in an ultrasonic cleaner for 10 to 20 seconds. Do not soak it for too long, since there is an increased risk of damaging the coating. Please use only water for cleaning the probe.

! CAUTION !

- !) When cleaning, make sure that the power is turned OFF.
- !) Make sure that the sensor is dry before turning it ON.
- !) DO NOT let the humidity sensor come into contact with water (MODEL6531/6533). When wet, let it air dry by placing it in an environment with less than 40%RH for more than 24 hours.
- !) NEVER USE alcohol or any other organic fluid. Alcohol will cause permanent damage to the humidity sensor. Once the sensor is damaged, it will need to be replaced even if it seems to be functioning.

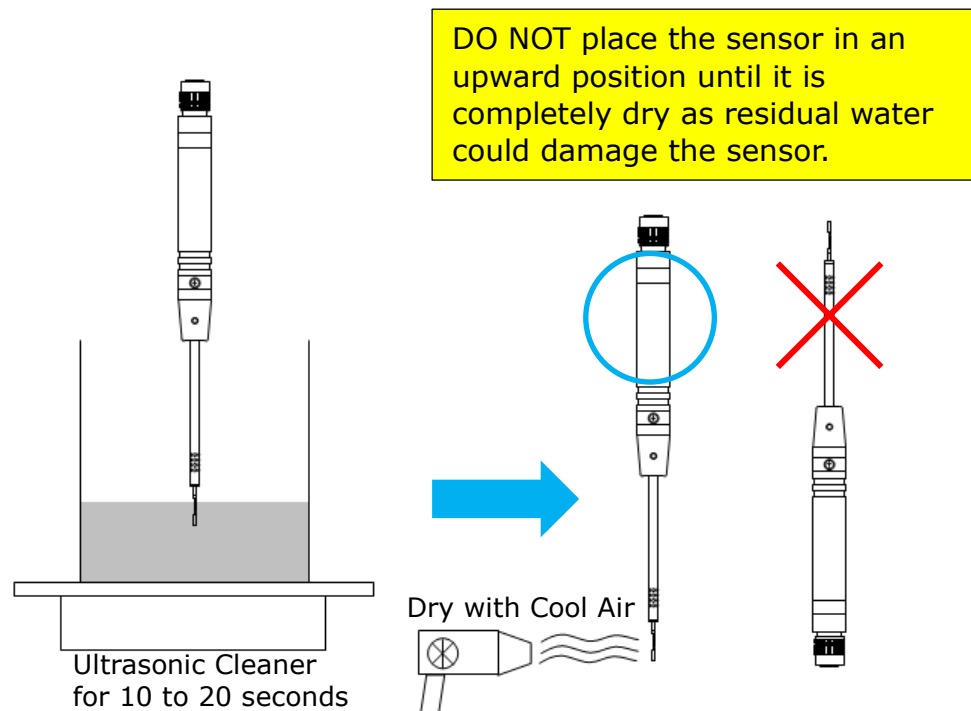

§ 12 Specification

Product		CLIMOMASTER Air Velocity Meter							
Model No. of the Main Body		6501							
Model No. of the Probe		6531-21	6541-21	6561-21	6542-21	6551-21	6552-21	6533-21	6543-21
Measuring Object		Clean air flow							
Air Velocity [m/s]	Measuring Range	0.01 to 30.0, 0.01 to 50.0 (6561-21 only)					0.01 to 5.00		
	Resolution	0 to 9.99: 0.01 10 to 30: 0.1 30 to 50: 0.1 (6561-21 only)					0.01		
	Accuracy	±2% of reading or ±0.015 (±3FPM), whichever is greater					0.01 to 0.99:±0.02 0.99 to 5.00: ±2% of reading or ±0.015 (±3FPM), whichever is greater		
	Response Time [sec.]	Approx. 1	Approx. 4		Approx. 7		Approx. 7		
		(at 1m/s, 90% response time)							
Air Temperature [°C]	Measuring Range	-20.0 to 70.0			-		-20.0 to 70.0		
	Resolution	0.1			-		0.1		
	Accuracy	±0.5			-		±0.5		
	Response Time [sec.]	Approx. 30 (at 1m/s, 90% response time)			-		Approx. 30 (at 1m/s, 90% response time)		
Humidity* ¹ [%RH]	Measuring Range	2.0 to 98.0	-				2.0 to 98.0	-	
	Resolution	0.1	-				0.1	-	
	Accuracy	2 to 80: ±2.0 80 to 98: ±3.0	-				2 to 80: ±2.0 80 to 98: ±3.0	-	
	Response Time [sec.]	Approx. 15	-				Approx. 15	-	
Pressure* ² [kPa]	Measuring Range	-5.00~+5.00							
	Resolution	0.01							
	Accuracy	±3% of reading or ±0.01							
	Response Time [sec.]	Approx. 1							
Temperature Compensation [m/s]	±5% of reading or ±0.015 (±3FPM), whichever is greater (in the temperature range of 5 to 60.0°C)								
Functions	Readings Hold, Max Hold, Time Constant (1, 5, 10 sec.), Battery Level Indicator (5 Levels), Unit selection (Air Velocity: m/s or FPM, Flow Rate: m ³ /min, m ³ /h, ft ³ /min, or ft ³ /h, Temperature* ¹ : °C or °F, Humidity* ² : %RH, Static Pressure* ³ : kPa or Pa) Max., Min., and Average Calculation, Sampling Time: 1 to 999 sec. No. of trails: 1 to 9999, Store up to 25 Duct Sizes (Square/Round, Size Range: 1 to 9999mm or 0.1 to 999.9inch(diameter, height, width)) Max.Data Storage: 20000								
Output	Digital Output: USB (when connected to a printer, automatically switch to RS-232C, Baud Rate 4800, 9600, 19200 and 38400 bps) Analog Output* ³ : DC 0 to 1V (select one from Air Velocity, Temperature* ¹ , Humidity* ² and Pressure* ³)								
Power	6 × AA Batteries , AC Adaptor* ⁴ : AC 100 to 240V (50/60Hz)								
Battery Life	Approximately 10 continuous hours (at air velocity 5m/s, 20°C, with alkaline batteries)								
Operating Environment	Main Body: 5 to 40°C (41 to 104°F) with no visible condensation Probe: -20 to 70°C (-4 to 158 °F) with no visible condensation								
Storage Environment	-10 to 50°C (14 to 122° F) with no visible condensation								
Weight	Approximately 400g (batteries included)								
Accessories	Carrying case, Operation manual, 6×AA Batteries, Probe cable (2m), USB cable								
Options	Spare probe, Analog output, Pressure sensor, Extension rod, Printer, Printer cable, Software (for Windows), AC adaptor, Hands-free Case								

*1: Air temperature is only available on MODEL6531/6541/6542/6533/6543/6561

*2: Humidity is only available on MODEL6531/6533

*3: Pressure is only available on MODEL6501-B0/-C0 , Analog Output is only available on MODEL6501-A0/-C0

*4: Optional.

§ 13

Principle of Measurement

Principle of Hot-wire Anemometer

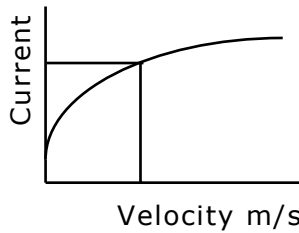
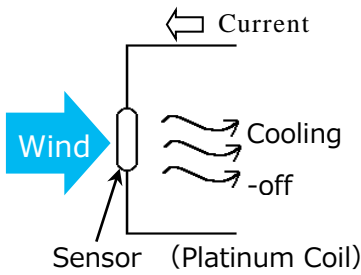

The principle of the thermal Probe is based on a heated element from which heat is extracted by the colder impact flow. The temperature is kept constant via a regulating switch. The controlling current is directly proportional to the velocity. When thermal velocity Probes are used in turbulent flows, the measured result is influenced by the flows impacting the heated body from all directions.

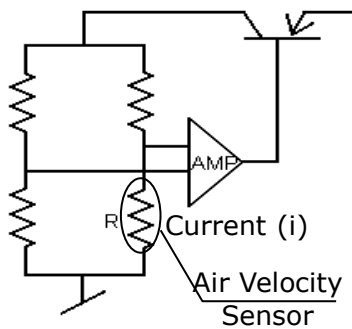

In turbulent flows, a thermal velocity sensor indicates higher measured values than a vane Probe. This can be observed during measurements in ducts. Depending on the design of the duct, turbulent flows can occur even at low velocities. The amount of heat that is extracted by the colder impact flow from the sensor can be expressed by:

$$H = (a + b\sqrt{U})(T - Ta) \quad \dots\dots King's fomula$$

Where H: Heat diffusion quantity T: Temperature of the sensor Ta: Air temperature U: Air velocity a, b: Constant

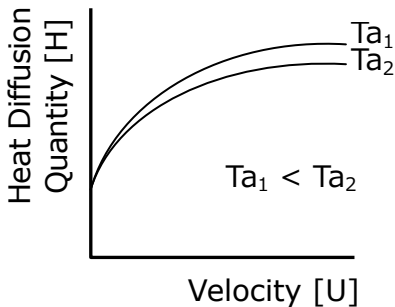

Also, heat diffusion quantity can be expressed by the formula:

$$H = RI^2$$

Where R is resistance and I is current (R is kept constant regardless of air velocity since the temperature in constant).

Therefore,

$$RI^2 \propto a + b\sqrt{U}$$

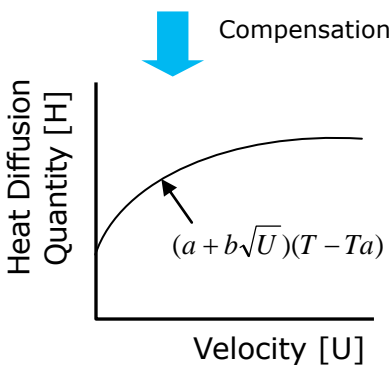

The Temperature Compensation

The air velocity sensor is heated to an elevated temperature relative to the surrounding air by means of control electronics. The temperature compensation sensor senses the ambient, or surrounding air temperature and forces the velocity sensor to stay at a constant overheat above the ambient. The circuit forces the voltage to be equal by means of an operational amplifier. Air flowing past the sensor tends to cool the sensor, thus driving down its resistance. The amplifier responds by immediately delivering more power to the circuit to maintain voltage equilibrium. Delivered power is converted into an electrical signal to display.

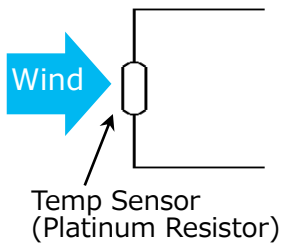

Measurement of Wind-Temperature
(MODEL 6531/6541/6542/6533/6543/6561)

The coefficient of resistance of the temperature sensor has a direct proportional relationship with the temperature. We can measure the wind temperature by adjusting the sensor's temperature to the wind-temperature, and measuring its coefficient of resistance.

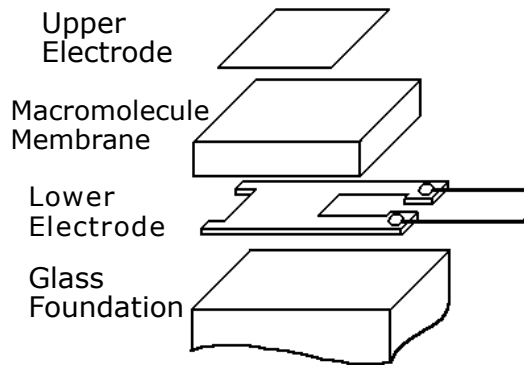

Measurement of Humidity (Hygrometer)
(MODEL 6531/6533)

The sensor is a pair of condensers and its electro-capacity is dependent upon the amount of water contained in its hydrophilic macromolecule (humidity sensitive) membrane.

The components of the sensors are a glass foundation; a lower electrode; a macromolecule membrane and an upper electrode.

The upper electrode will capture the change in permittivity caused by condensation or evaporation of water vapors to the macromolecule membrane. (Electrostatic Capacity Type)

There is another type of hygrometer that uses a resistor instead of a condenser. Typically Electrostatic Capacity types are good for low humidity measurements and the resistor types are good for high humidity measurements.

Theory of detecting static pressure (MODEL 6501-B0/6501-C0)

To measure static pressure, we use a diffusion-type semiconductor pressure sensor. The diffusion-type semiconductor pressure sensor is incorporated under the principle that the resonant frequency of a piezo-crystal decreases linearly with the pressure applied. On a thin diaphragm of silicon, there are four diffusion resistors (sensor chips) placed in a fixed distant apart. (Pic.1)

When the pressure is applied from above, the diaphragm will deflect downward. When it is deflected, the sensors near the center (R3 and R4) will have compressing stress and the sensors near the perimeter (R1 and R2) will have tensile stress instead. (Pic.2) The diffusion coefficient of the diffusion resistor changes according to these two stresses.

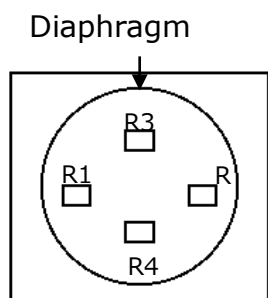

R1~R4 : Diffusion Resistant
Pic.1 Pressure Sensor

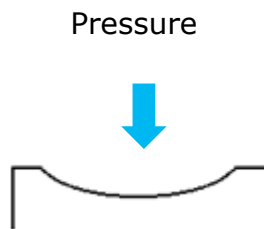

Pic.2

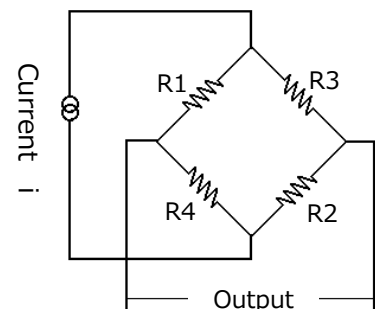

Pic.3 Detecting Circuit

If we create a bridge among these diffusion resistors (Pic.3), it is possible to detect voltage that is proportional to the amount of pressure applied. These sensors can be affected by the temperature, and therefore, a temperature compensation circuit must be added.

What are Discomfort Index (DI) and Dew Point Temperature (DT)?

* * What is DI and DT? * *

- Discomfort Index (DI)

Discomfort Index is an index to show how uncomfortable it is in the summer time.

CLIMOMASTER use the formula, shown below, which is used by Meteorological Agencies.

$$DI = 0.81T + 0.01H(0.99T - 14.3) + 46.3$$

Where

T: Temperature (°C)

H: Relative Humidity (%RH)

DI Scale

	Comfortable	Little Uncomfortable	Uncomfortable	Very Uncomfortable	Cannot Endure
	68	70	75	80	86

- There are many formulas to calculate Dew Point Temperature, but for A531, we have adopted the most general "Antnionne" formula, which is used to calculate saturated vapor pressure.

$$E = \exp[18.6686 - 4030.183 / (235 + T)] \times 133.322$$

$$e = \frac{H \times E}{100}$$

Where

H : Relative Humidity (%RH)

T : Temperature (°C)

E : Saturated Vapor Pressure (Pa)

e : Vapor Pressure (Pa)

$$DT = 4030.183 / [23.5614 - \ln(e)] - 235$$

About Compensation

This instrument has been calibrated at normal temperature and pressure. Therefore, if you are going to measure velocity at a different temperature and pressure, the indicating value will be affected.

Influence of Measuring Temperature

This instrument has been calibrated at normal temperature. Because of theoretical fundamentals of hot-wire anemometers, it can easily be effected by the ambient temperature. To prevent such influence, temperature compensation is needed. The temperature compensation sensor senses the ambient, or surrounding air temperature and forces the velocity sensor to stay at a constant overheat above the ambient temperature. By adopting temperature compensation sensors, you can measure air velocity accurately within a range of 5~60 °C (41~140°F)

Influence of Pressure at Measuring Point

The instrument is calibrated under atmospheric pressure of 1013 hPa. Since change in the atmospheric pressure will influence the heat dissipation amount, compensation of the atmospheric pressure is required. Compensation can be provided by using the following formula.

$$Um = \frac{1013}{Pm} \times Uc$$

Where: Um: Actual Velocity[m/s]

Uc: Indicating Value

Pm: Atmospheric Pressure at the Measuring Point [hPa]

Measuring Gas Components

This instrument has been calibrated using normal air (i.e. 79% nitrogen concentration & 21% oxygen concentration). If you wish to use the instrument in an environment other than normal air, you will need to compensate for the characteristics of the gas mixture you'll be using the instrument in. Please contact your local Kanomax representative for details.

§ 14

Probe Directivity (Air Velocity)

MODEL 6531-21 / 6541-21 / 6561-21

Horizontal

Wind Direction Indicator

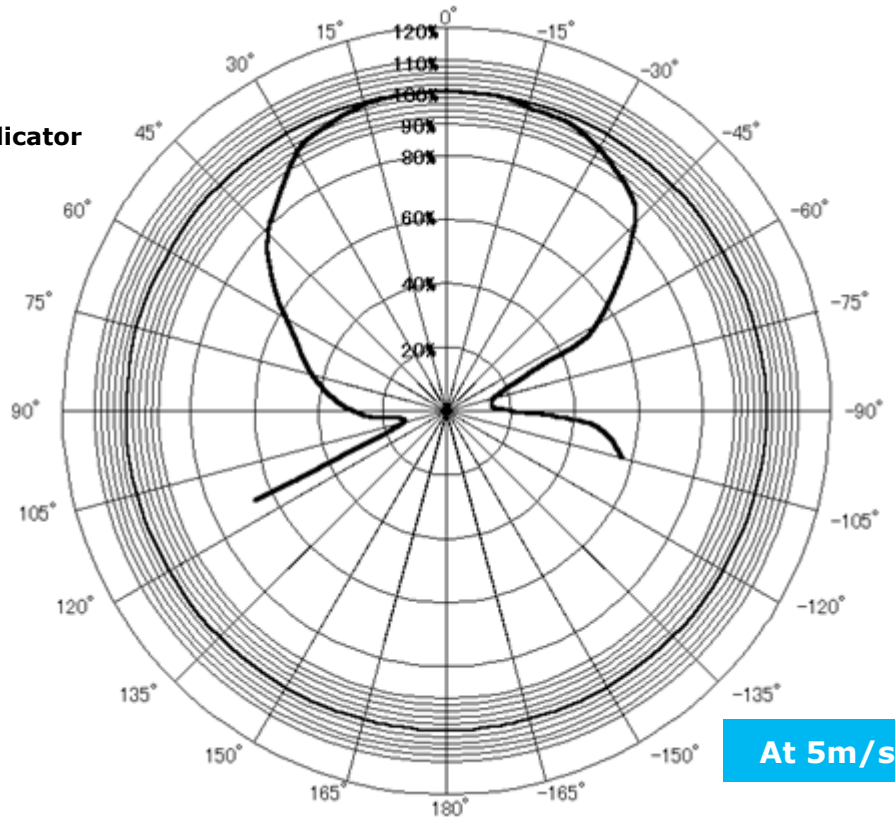
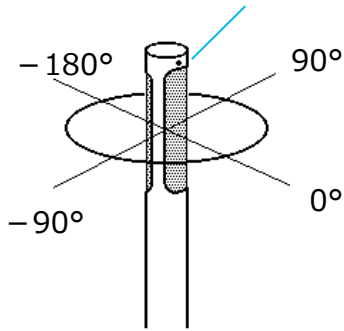

At 5m/s

Vertical

Wind Direction Indicator

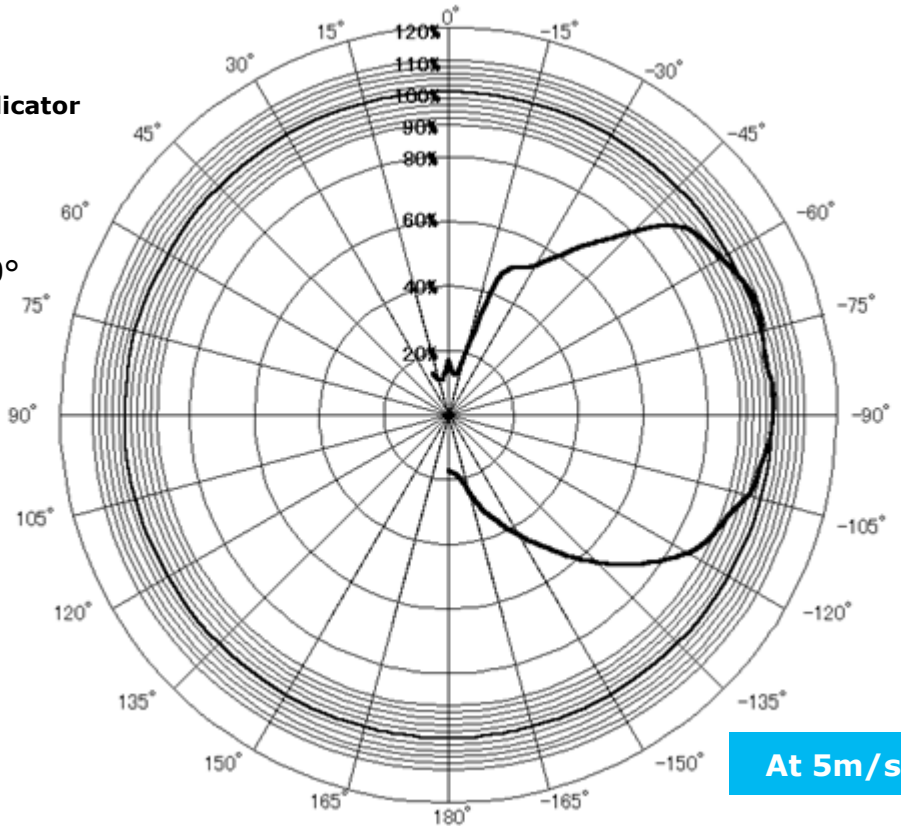
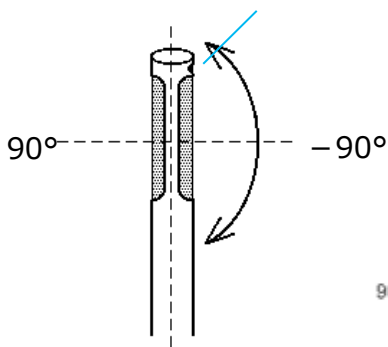

At 5m/s

Probe Directivity (Air Velocity)
MODEL 6542-21

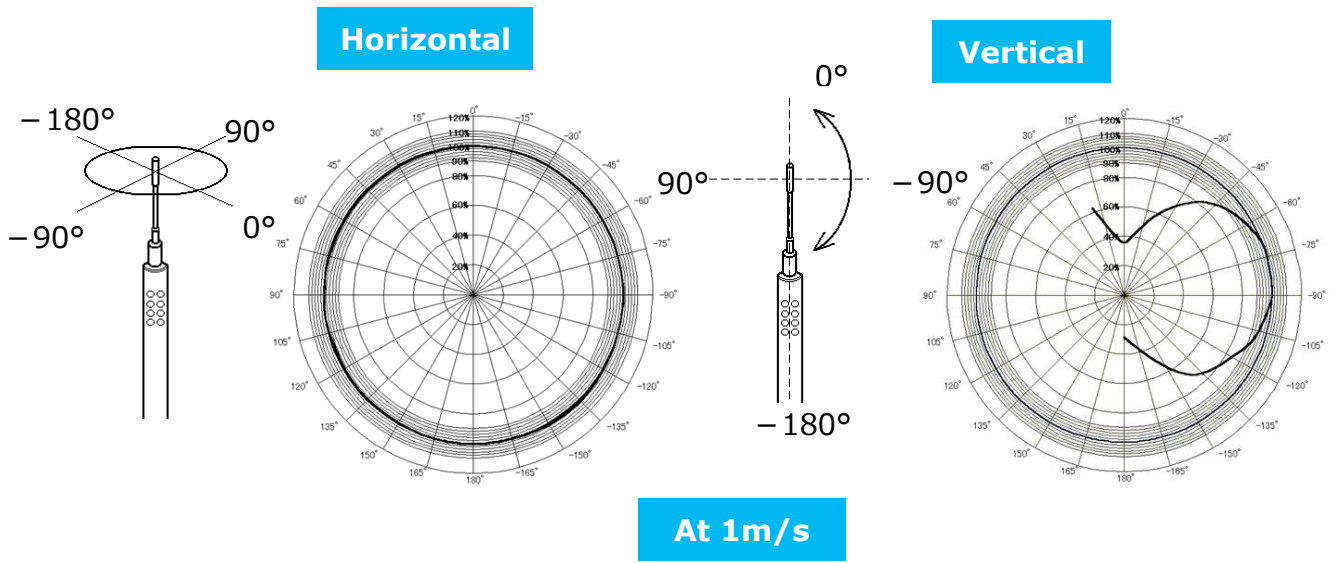

Probe Directivity (Air Velocity)
MODEL 6533-21/6543-21/6551-21/6552-21

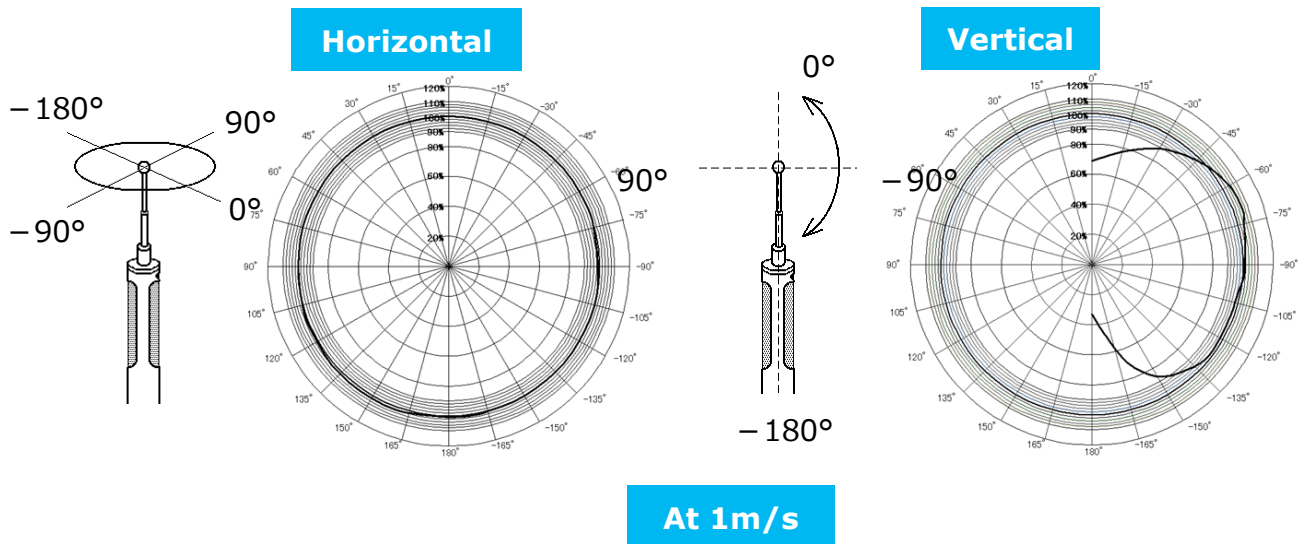

§ 15 Trouble Shooting

Check battery

Problem	Possible cause(s) / Solution(s)	Reference
The instrument will not turn on	Battery is inserted in wrong polarity. → Turn off the power and insert the battery correctly.	Page 11 & 13
The display is not visible	Display contrast is not set up properly. → Adjust the contrast volume switch.	Page 50
The battery level indicator  flashes on the display	The battery is low. → Turn off the instrument and replace the batteries.	Page 11 & 13



Initial operational check

Problem	Possible cause(s) / Solution(s)	Reference
The display is not visible	The display contrast is not set up properly. → Adjust the contrast dial.	Page 50
[NO PROBE] is displayed	The probe is not connected. → Turn off the instrument and connect a probe.	Page 12
Can I change the measurement unit?	Yes, you can change measurement units by following the steps on page 46.	Page 46

Normal operational check

Problem	Possible cause(s) / Solution(s)	Reference
[**.*] is displayed as measured value.	It indicates the measurement is outside the measuring range. → The instrument must be used in the range stated in the specifications.	Page 52
[- - - -] is displayed as air velocity measurement.	The probe or the probe cable is not connected properly. → Check the connection between the probe and the probe cable.	Page 12
	The probe or the probe cable may be damaged. → Contact your local Kanomax representative for repair or replacement.	Page 62
The instrument is not reading the correct air speed.	The probe might be not facing into the wind. → Make sure the wind direction indicator is facing into the wind.	Page 14
The instrument reads a higher temperature with no wind.	CLIMOMASTER can't measure the correct temperature with no wind (less than 0.1m/s of wind). *Model 6533 and 6543 can measure less than 0.1 m/s.	Page 14
The response time is slow	Set the correct time constant (TC).	Page 20
[- - - -] is displayed as the air volumetric flow measurement.	The duct information (shape and size) is not stored. → Register duct information.	Page 16

Output check (1) - Print out

Problem	Possible cause(s) / Solution(s)	Reference
The printer doesn't operate.	The printer is not connected properly. → Confirm the printer connection.	Page 34
	The Baud Rate might not be set properly. → Check both the instrument and printer settings.	Page 46
	Make sure to use the optional printer (Model DPU-S245) and printer cable (Model 6000-31).	Page 34
	Confirm the connection procedure. → Connect the printer to the printer port, then turn on the instrument and printer.	Page 34
Cannot printout the display	Display is not frozen. → 1. Press  to hold the display. 2. Press  to print out.	Page 34
Want to cancel printing	You can't cancel print while it is operating.	Page 34

Output check (2) - Digital output

Problem	Possible cause(s) / Solution(s)	Reference
PC doesn't load the measuring data.	Confirm the USB connection, which is different from printer connection.	Page 39
	The Baud Rate might not be set properly. → Check both the instrument and PC settings.	Page 34
	Confirm the communication command (ex. Hyper Terminal command).	Page 39

Output check (3) - Analog output

Problem	Possible cause(s) / Solution(s)	Reference
No data is generated.	Check the connection and confirm the polarity.	Page 43
	The HOLD function might be active. → Press  to cancel the HOLD function.	Page 43
Data is tiered.	Data is outputted every one second.	Page 43
The output data is not correct.	Confirm the setting for analog output.	Page 43
	Confirm the output range.	Page 43
	The load impedance might not be optimum. Set the load impedance larger than 5k Ω.	Page 43

§ 16 Warranty and After Service

Kanomax Limited Warranty

The limited warranty set forth below is given by KANOMAX JAPAN, Inc. (hereafter referred to as "KJI") with respect to the KANOMAX brand anemometer, and its attachment parts including probe and other accessories (hereafter referred to as "PRODUCT") purchased directly from KJI or from an authorized distributor.

Your PRODUCT, when delivered to you in new condition in its original container, is warranted against defects in materials or workmanship as follows: for a period of two (2) years from the date of original purchase, defective parts or a defective PRODUCT returned to KJI, as applicable, and proven to be defective upon inspection, will be exchanged for a new or comparable rebuilt parts, or a refurbished PRODUCT as determined by KJI. Warranty for such replacements shall not extend the original warranty period of the defective PRODUCT.

This limited warranty covers all defects encountered in normal use of the PRODUCT, and does not apply in the following cases:

- (1) Use of parts or supplies other than the PRODUCT sold by KJI, which cause damage to the PRODUCT or cause abnormally frequent service calls or service problems.
- (2) If any PRODUCT has its serial number or date altered or removed.
- (3) Loss of damage to the PRODUCT due to abuse, mishandling, alternation, improper packaging by the owner, accident, natural disaster, electrical current fluctuations, failure to follow operation, maintenance or environmental instructions prescribed in the PRODUCT's operation manual provided by KJI, or service performed by other than KJI.

NO IMPLIED WARRANTY, INCLUDING ANY IMPLIED WARRANTY OF MERCHANTABILITY OR FITNESS FOR A PARTICULAR PURPOSE, APPLIES TO THE PRODUCT AFTER THE APPLICABLE PERIOD OF THE EXPRESS LIMITED WARRANTY STATED ABOVE, AND NO OTHER EXPRESS WARRANTY OR GUARANTY, EXCEPT AS MENTIONED ABOVE, GIVEN BY ANY PERSON OR ENTITY WITH RESPECT TO THE PRODUCT SHALL BIND KJI. KJI SHALL NOT BE LIABLE FOR LOSS OF STORAGE CHARGES, LOSS OR CORRUPTION OF DATA OR ANY OTHER SPECIAL, INCIDENTAL OR CONSEQUENTIAL DAMAGES CAUSED BY THE USE OR MISUSE OF, OR INABILITY TO USE OR CONSEQUENTIAL DAMAGES CAUSED BY THE USE OR MISUSE OF, OR INABILITY TO USE, THE PRODUCT, REGARDLESS OF THE LEGAL THEORY ON WHICH THE CLAIMS IS BASED, AND EVEN IF KJI HAS BEEN ADVISED OF THE POSSIBILITY OF SUCH DAMAGES. IN NO EVENT SHALL RECOVERY OF ANY KIND AGAINST KJI BE GREATER IN AMOUNT THAN THE PURCHASE PRICE OF THE PRODUCT SOLD BY KJI AND CAUSING THE ALLEGED DAMAGE. WITHOUT LIMITING THE FOREGOING, THE OWNER ASSUMES ALL RISK AND LIABILITY FOR LOSS, DAMAGE OF, OR INJURY TO THE OWNER AND THE OWNER'S PROPERTY AND TO OTHERS AND THEIR PROPERTY ARISING OUT OF USE OR MISUSE OF, OR INABILITY TO USE, THE PRODUCT NOT CAUSED DIRECTLY BY THE NEGLIGENCE OF KJI. THIS LIMITED WARRANTY SHALL NOT EXTEND TO ANYONE OTHER THAN THE ORIGINAL PURCHASER OF THE PRODUCT, OR THE PERSON FOR WHOM IT WAS PURCHASED AS A GIFT, AND STATES THE PURCHASER'S EXCLUSIVE REMEDY.

After Service

•When you have a problem with your instrument, please check out "Troubleshooting" first.

•If that does not solve the problem, please contact your local distributor or call our service center. (See last page for contact information.)

•During the warranty period, we will repair at no charge a product that proves to be defective due to material or workmanship under normal use. (Kanomax Limited Warranty.)

•Repair after warranty expiration:

Upon request, we will repair the instrument at the customer's expense, if the instrument's performance is found to be recoverable by providing the repair.

•Replacement parts are available for minimum period of five (5) years after termination of production. This storage period of replacement parts is considered as the period during which we can provide repair service. For further information, please contact your local distributor or our service center.

§ 17 Contact Information



2012

No copying, distribution, publication, modification, or incorporation of this document, in whole or part, is permitted for commercial purposes without the express written permission of Kanomax.

The contents of this document may be changed without prior notice.

01002/12.04