

Table of Contents

Table of Contents	2
Foreword	3
Statements of Compliance	3
Warranty	4
For Your Safety	5
Technical Support	5
1.0 Monitor and System Components	6
1.1 IQM 60	6
1.2 System Components include:	6
2.0 Description	6
2.1 Inlets	7
3.0 Operating Instructions	8
3.1 Getting Started	8
3.2 Connecting a computer	8
3.3 Reading the Datacard	8
3.4 Testing	8
3.5 Maintenance	8
3.6 Care and Cleaning	8
4.0 Troubleshooting	9
4.1 Troubleshooting Guide	9
4.2 Diagnostics	10
5.0 Calibration	11
5.1 Gas Module Calibration	11
5.1.1 Nafion Humidifier	11
5.1.2 Zero verification using Gas Treatment Module	12
5.1.3 Zero calibration	12
5.1.3.1 Using Gas Treatment Module	12
5.1.3.2 Laboratory Zero calibration	12
5.1.4 Span calibration	12
5.1.4.1 Span gas	12
5.1.4.2 Span calibration procedure	13
5.2 Particle Counter Calibration	14
Flow rate	14
Zero Check	14
Span Calibration	14
Appendix A AQM V5.x Software Instructions	15
Description	15
Setting up	15
Passwords	15
Menu Descriptions	15
File	15
Setup	17
Data	19
Tools	22
Diagnostics	26
Window	28
Help	29
Additional Buttons	29
Updating Sensor List	29
Appendix B Communication Protocol	30
Enclosure	42
External View	42
Description	42
Dimensions	42
Front View	43
Rear View	43

Foreword

Copyright Aeroqual Limited. All rights reserved. Reproduction, transfer, distribution or storage of part or all of the contents of this document in any form without the prior written permission of Aeroqual Limited is prohibited.

“Aeroqual” and “Aeroqual Limited – Making the Invisible Visible” are registered trademarks of Aeroqual Limited. Other product and company names mentioned herein may also be trademarks or trade names.

Aeroqual operates a policy of continuous development. Aeroqual reserves the right to make changes and improvements to any of the products described in this document without prior notice.

Under no circumstances shall Aeroqual be responsible for any loss of data or income or any special, incidental, consequential or indirect damages howsoever caused.

The contents of this document are provided “as is”. Except as required by applicable law, no warranties of any kind, either express or implied, including, but not limited to, the implied warranties of merchantability and fitness for a particular purpose, are made in relation to the accuracy, reliability or contents of this document.

Aeroqual reserves the right to revise this document or withdraw it at any time without prior notice. The availability of particular products may vary by region. Please check with the Aeroqual dealer nearest to you.

Statements of Compliance

1. The Aeroqual IQM Monitor complies with EN 61000-6-1:2001
2. The Aeroqual IQM Monitor complies with EN 61000-6-3:2001
3. The Aeroqual IQM Monitor complies with Part 15 of the FCC Rules. Operation is subject to the following two conditions: (1) these devices may not cause harmful interference, and (2) these devices must accept any interference received, including interference that may cause undesired operation.

NOTE: This equipment has been tested and found to comply with the limits for a Class B digital device, pursuant to Part 15 of the FCC Rules. These limits are designed to provide reasonable protection against harmful interference in a residential installation. This equipment generates, uses and can radiate radio frequency energy and, if not installed and used in accordance with the instructions, may cause harmful interference to radio communications. However, there is no guarantee that interference will not occur in a particular installation. If this equipment does cause harmful interference to radio or television reception, which can be determined by turning the equipment off and on, the user is encouraged to try to correct the interference by one or more of the following measures:

- Reorient or relocate the receiving antenna.
- Increase the separation between the equipment and receiver.
- Connect the equipment into an outlet on a circuit different from that to which the receiver is connected.
- Consult the dealer or an experienced radio/TV technician for help.



Warranty

Thank you for purchasing this Aeroqual product. To get maximum use of the features of your new product we recommend that you follow a few simple steps:

- Read the guidelines for safe and efficient use.
- Read all the terms and conditions of your Aeroqual Warranty.
 - Save your original receipt. You will need it for warranty repair claims. Should your Aeroqual product need warranty service, you should return it to the dealer from whom it was purchased or contact Aeroqual.

Our Warranty

Aeroqual warrants this product to be free from defects in materials and workmanship for a period of 1 (one) year from the date of shipment from the factory. Consumable items such as bearings, filters and gas scrubber media are excluded from this warranty.

This warranty is expressly limited to the original owner who purchases the equipment directly from Aeroqual or from an authorized Aeroqual dealer.

What we will do

If, during the warranty period, this product fails to operate under normal use and service, due to improper materials or workmanship, Aeroqual subsidiaries, authorized distributors or authorized service partners will, at their option, either repair or replace the product in accordance with the terms and conditions stipulated herein.

Conditions

1. The warranty is valid only if the original receipt issued to the original purchaser by the dealer, specifying the date of purchase, is presented with the product to be repaired or replaced. Aeroqual reserves the right to refuse warranty service if this information has been removed or changed after the original purchase of the product from the dealer.
2. If Aeroqual repairs or replaces the product, the repaired or replaced product shall be warranted for the remaining time of the original warranty period or for ninety (90) days from the date of repair, whichever is longer. Repair or replacement may be via functionally equivalent reconditioned units. Replaced faulty parts or components will become the property of Aeroqual.
3. This warranty does not cover any failure of the product due to normal wear and tear, damage, misuse, including but not limited to use in any other than the normal and customary manner, in accordance with Aeroqual's user guide for use, faulty installation, calibration and maintenance of the product, accident, modification or adjustment, events beyond human control, improper ventilation and damage resulting from liquid or corrosion.
4. This warranty does not cover product failures due to repairs, modifications or improper service performed by a non-Aeroqual authorized service workshop or opening of the product by non-Aeroqual authorized persons.
5. The warranty does not cover product failures which have been caused by use of non-Aeroqual original accessories.
6. This warranty becomes void if a non-Aeroqual approved power supply is used.
7. Tampering with any part of the product will void the warranty.
8. Damage to the sensors can occur through exposure to certain sensor poisons such as silicones, tetraethyl lead, paints and adhesives. Use of Aeroqual sensors in these environments containing these materials may (at the discretion of Aeroqual) void the warranty on the sensor head. Exposure to gas concentrations outside of the design range of a specific Aeroqual sensor head can adversely affect the calibration of that sensor head and will also void this warranty as it applies to the replacement of sensor heads.
9. Aeroqual makes no other express warranties, whether written or oral, other than contained within this printed limited warranty. To the fullest extent allowable by law all warranties implied by law, including without limitation the implied warranties of merchantability and fitness for a particular purpose, are expressly excluded, and in no event shall Aeroqual be liable for incidental or consequential damages of any nature whatsoever, however they arise, from the purchase or use of the product, and including but not limited to lost profits or business loss.
10. Some countries restrict or do not allow the exclusion or limitation of incidental or consequential damage, or limitation of the duration of implied warranties, so the preceding limitations or exclusions may not apply to you. This warranty gives you specific legal rights, and you may also have other rights, which may vary from country to country.

1.0 Monitor and System Components

1.1 IQM 60

The Aeroqual IQM 60 Environmental Monitor is a custom-built indoor air quality instrument which can be configured with up to six gas sensor modules as well as options such as a particle counter. The configuration of the instrument supplied is determined by the sensor modules and options that were ordered.

The IQM60 uses an internal pump to sample the air via the gas sensor inlet and the particle counter inlet if fitted.

This manual describes the general use and operation of the IQM Environmental Monitor. The Product Information Sheet supplied at the front of the folder will specify the "as-built" monitor and the packing list of shipped items. Please check that all the components have been supplied as per your order and contact your dealer if any of the components are missing.

1.2 System Components include:

- IQM 60 Monitor
- 12VDC Regulated Power Supply
- Temperature and humidity sensor extension cable
- Computer CD containing software for data logging and calibrating IQM
- Data Card (1GB)
- Data card reader
- Serial Cable
- Nafion humidifier

2.0 Description

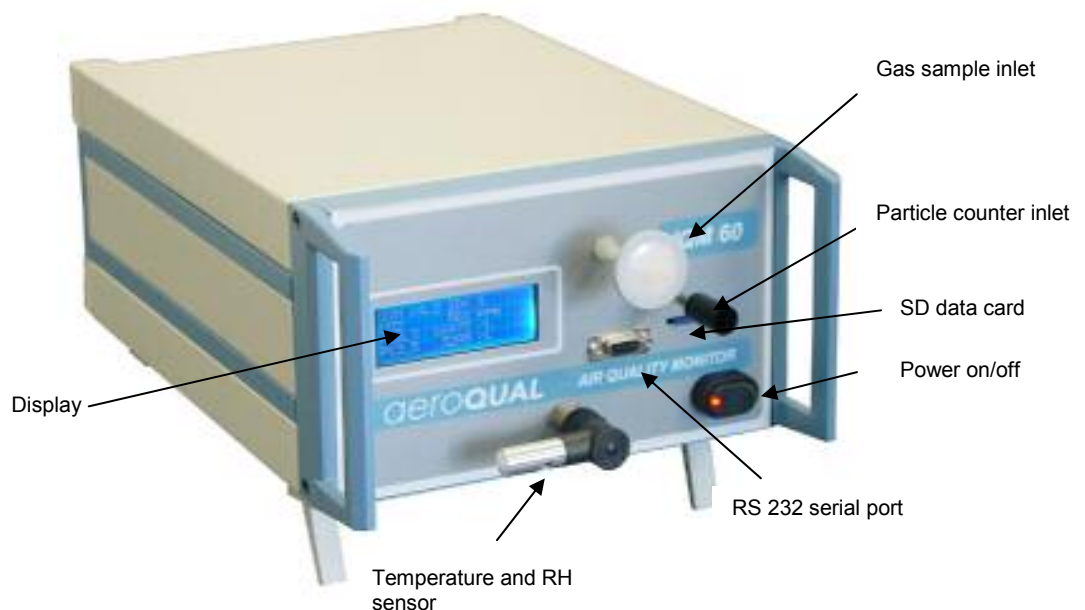

NOTE 1. Insert the data card by pressing in gently until the card latches in place. To remove the data card gently press inwards and then let go to release the latch. Always turn off the IQM 60 before removing or inserting the data card.

2.1 Inlets

The IQM is supplied with an isokinetic probe for the particle counter inlet and a teflon filter for the gas sensor inlet. These should be fitted before starting the IQM. There is also a zero filter supplied for zero checking the particle counter.

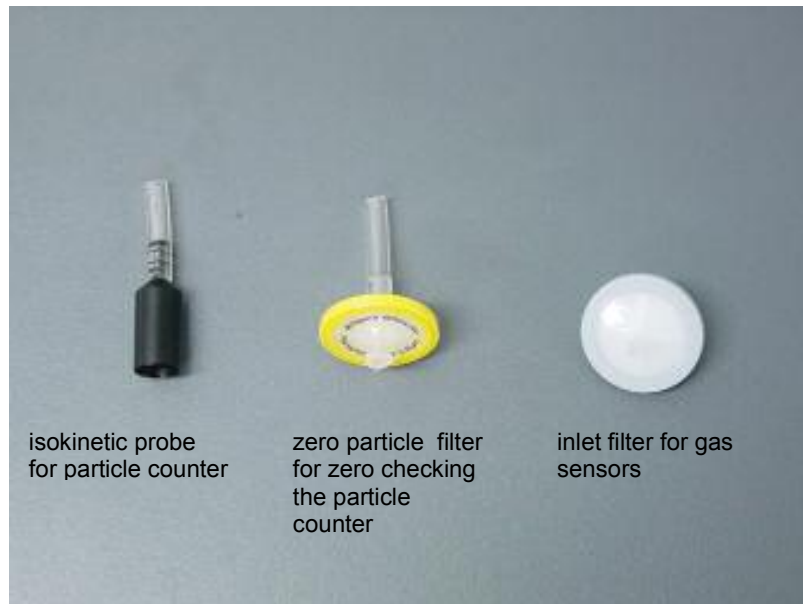

3.0 Operating Instructions

3.1 Getting Started

The IQM 60 is simple to operate:

- Ensure that the 12VDC power supply to the IQM 60 is connected (rear panel).
- Ensure the datacard is correctly inserted in the slot.
- Turn on the power switch (front panel).
- Remove the inlet cap and fit the supplied filter to the inlet

Note: The IQM 60 should be allowed to run for 60 minutes so that it is fully warmed up before taking readings.

3.2 Connecting a computer

The connection of a computer to the IQM 60, the installation of the software and its use are described in Appendix A.

3.3 Reading the Datacard

Data is stored on the data card as a daily file. The format of the data is a tab delimited file which can be opened with standard graphical software such as MS Excel. Always turn off the IQM 60 before removing or inserting the data card. To remove the data card gently press inwards and then let go to release the latch.

3.4 Testing

Zero and span checks should be performed with humidified air (detailed description provided in section 5). Aeroqual supplies a Nafion gas humidifier. If the IQM is to be deployed in environments with low or high absolute humidity it is recommended that the sensors be zero and span calibrated under those conditions, since the sensors are slightly sensitive to changes in absolute humidity.

3.5 Maintenance

The IQM is designed to operate without maintenance for extended periods. The following table outlines a periodic maintenance schedule for the IQM. This schedule is based on experience under normal operating conditions and may need to be modified to suit specific operating conditions.

Interval	Item	Procedure
Weekly	Gas Sensor zero check	Perform using inbuilt Zero scrubber
	Particle Counter zero check	Perform
1 Month	Inlet particulate filter	Check/replace
	Particle Counter flow test	Perform
6 Months	Gas Sensor Span calibration	Perform
1 Year	Particle Counter Factory Service	Contact Aeroqual for instructions

3.6 Care and Cleaning

- Keep the IQM dry. Avoid water and/or condensation as humidity and liquids containing minerals may corrode electronic circuits.
- Do not use or store in dusty, dirty areas.
- Do not store or turn off the monitor in temperatures below 5°C.
- This unit is designed for use at temperatures between 5°C and +45°C. If you wish to use the monitor outside this range you will need an additional environmental enclosure. Sudden changes in temperature will cause condensation that may damage the electronic components.
- Do not drop, knock or shake as this could lead to internal damage.

4.2 Diagnostics

The IQM has a number of sources for diagnostic information if a problem arises. These are described below:

Event log A large number of instrument events are logged on the event log file which is located on the SD data card. This can be downloaded remotely (if a modem is fitted) and in many cases can be used to determine whether a site visit is required.

Event Code Examples	Meaning
O3 :P.F. 2008/11/12 23:45	Pump failure O3 module pump failure on 12 Nov 2008 at 23:45
NO2 :S.F. 2008/11/12 23:45	Sensor failure NO2 module sensor failure on 12 Nov 2008 at 23:45
Power on: 2008/11/12 10:12	AQM Power turned on at 10:12 am on 12 November 2008
Zero Cal at 2008/11/12 11:24	Zero Calibration started at 11:24 on 12 November 2008
Config at 2008/11/12 13:12 0x01,05,30,40,50,B0,F8,00,00,00,00,00,00,00,00,00	AQM configuration saved at 1:12 pm on 12 November 2008 Sensor codes listed
O3 : NR 2008/11/12 12:42	O3 module no data report at 12:42 pm on 12 November 2008
NO2 Scrubber FAILED: 2008/11/12 15:36	NO2 scrubber failed at 3:36 pm on 12 November 2008

Messages

This is located on the AQM PC software tool bar. If the AQM is connected to the computer then event messages will be written to the Messages window in real-time.

Diagnostics

This is located in the AQM PC software. If the AQM is connected to the computer then individual sensor modules can be interrogated to determine if there is a problem not picked up by normal fault detection as well as fine tune the sensor performance. Only qualified personnel should use this menu as incorrect use may result in sensor malfunction. Please consult Aeroqual Technical Support to understand how to use this feature.

5.0 Calibration

5.1 Gas Module Calibration

All the Gas modules in the IQM can be calibrated in the unit by applying certified gas to the IQM inlet. All Zero and span calibrations or checks should be performed with humidified air and use single gas mixtures in a balance of air. If the IQM is to be deployed in environments with very low or high absolute humidity it is recommended that the sensors be zero and span calibrated under those conditions, since the sensors are slightly sensitive to changes in absolute humidity.

Zero and span adjustments on the IQM60 V5 are performed by adjusting the OFFSET and GAIN values under the Calibration menu. The equation that relates the OFFSET and GAIN to the Gas reading is given below:

$$\text{Gas Reading} = \text{GAIN} \times (\text{Module Reading} - \text{OFFSET})$$

All the Gas modules in the IQM can be calibrated in the unit by applying certified gas to the IQM inlet.

- **All zero and span calibrations or checks should be performed with gas mixtures in a balance of air. Note: the calibration standard may be in a balance of N2 but it should be diluted with air prior to presenting to the IQM.**
- **Fluorocarbon (PTFE, FEP or PFA) tubing and fittings should be used for all sample lines.**



Warm up the IQM for at least *12 hours* before attempting a gas sensor calibration

5.1.1 Nafion Humidifier

A Nafion tubing membrane humidifier is supplied with the IQM which can be used to humidify the air delivered to the IQM during calibrations. Two lengths of 1/4" Teflon tubes are supplied to enable connection to sample lines and the IQM inlet.

Span gas and zero air is typically dry (~0%RH) and the sensors used in the IQM require 50 +/-20% RH for best performance. The Nafion membrane is selectively permeable to water vapor (although some other compounds such as ammonia, alcohols, acetone, and acetic acid may also be transported across the membrane see www.permapure.com for further information) and the direction of transport is driven by the concentration gradient across the tubing wall. The humidifier is designed to extract water vapor from the surrounding ambient air and transfer this into the dry span or zero gas source. The resultant humidity in the sample gas is roughly half of that of the ambient air. If the surrounding air humidity is less than 50% it is recommended that the membrane is positioned above a water bath to increase the humidity in the sample air. Also, Make sure that the air surrounding the membrane is not contaminated with hydrocarbons that could be transported across the nafion to the sensors. If in doubt contact Aeroqual.



Nafion humidifier

5.1.2 Zero verification using Gas Treatment Module

The Gas Treatment Module contains a zero air scrubber which can be automatically or manually turned on to periodically measure the zero of the instrument. The automatic zero verification is set in the Configuration file under Zero Readings. This turns on the gas treatment module for 30 minutes during which time the sensors continue to measure. This procedure is repeated at a user defined interval between 1 and 255 hours. It is recommended that this procedure is used when making field measurements.

5.1.3 Zero calibration

5.1.3.1 Using Gas Treatment Module

You may use the zero air scrubber in the Gas Treatment Module to undertake a manual zero calibration. Before doing this you should check that the media are in good condition or if possible replace with fresh media.

1. Turn on the zero scrubber manually by clicking on PC software, Tools- >Turn On Zero Scrubber.
2. Allow the AQM to sample until stable readings are obtained (about 30 - 60 minutes).
3. Adjust the OFFSET values for each gas sensor via the Calibration --> Calibrate OFFSET-->enter password "password"--> select gas-->enter new OFFSET

$$\text{new OFFSET} = \text{old OFFSET} + \text{AQM60 gas reading}$$

5.1.3.2 Laboratory Zero calibration

The IQM can be re-zeroed via the PC software using a zero air source with relative humidity of 50% +/- 20%. Aeroqual can supply a humidifier that uses a Nafion membrane to humidify the air.

1. Connect a source of zero air to the IQM through the sample port using ¼ inch Teflon tubing. Use a T fitting to ensure the IQM is sampling the gas flow at atmospheric pressure. The zero air should be at least 1.5 LPM (check there is excess flow at the exhaust of the T fitting).
2. Allow the IQM to sample until stable readings are obtained (about 30-60 minutes).
3. Adjust the OFFSET values for each gas sensor via the Calibration --> Calibrate OFFSET-->enter password "password"--> select gas-->enter new OFFSET

$$\text{new OFFSET} = \text{old OFFSET} + \text{AQM60 gas reading}$$

5.1.4 Span calibration

The sensors can be manually span calibrated by modifying the individual gain factors for each sensor. Introduce a known concentration of span gas into the instrument and adjust the gain factor to set the correct concentration reading. Note: a sensor zero point calibration should always be performed before undertaking a span calibration.

5.1.4.1 Span gas

Span gas mixtures should be *single* gas mixtures that are certified and be in a *balance of air*.

- i** DO NOT USE MIXTURES THAT CONTAIN MORE THAN ONE SPAN GAS COMPONENT
- i** DO NOT USE A SPAN GAS IN A BALANCE OF NITROGEN UNLESS DILUTION IS GREATER THAN 50 TIMES WITH ZERO AIR.

The mixture should also be humidified to about 50 +/-20% RH by either using a Nafion membrane humidifier or by bubbling the zero grade air through water prior to mixing with the gas standard. Aeroqual can supply a Nafion humidifier which is suitable for IQM units containing O3, NO2, CO, SO2 and VOC sensor modules. Excessive gas concentrations should be avoided as these may damage the sensors or cause contamination of the internal tubing. Recommended span points for gas sensors are given in the table below.

5.2 Particle Counter Calibration

Flow rate

The sampling flow rate should be checked monthly and adjusted if required. To test the flow rate:

1. Remove the isokinetic probe and connect a flow meter to the barb fitting of the particle inlet using a short piece of flexible 1/8 " ID tubing, Tygon tubing is a good choice.
2. Turn on the IQM and note the flow meter reading. The flow rate should be 1.0 +/- 0.05 LPM
3. The flow rate can be adjusted by a screw flow adjuster located underneath the bottom panel of the IQM (see below). To remove the bottom panel, remove the two screws located at the bottom rear corners of the casing and the bottom panel lifts off. Use a screw driver to adjust the screw in the T piece fitting. Turn the screw clockwise to decrease the flow and counter-clockwise to increase the flow.

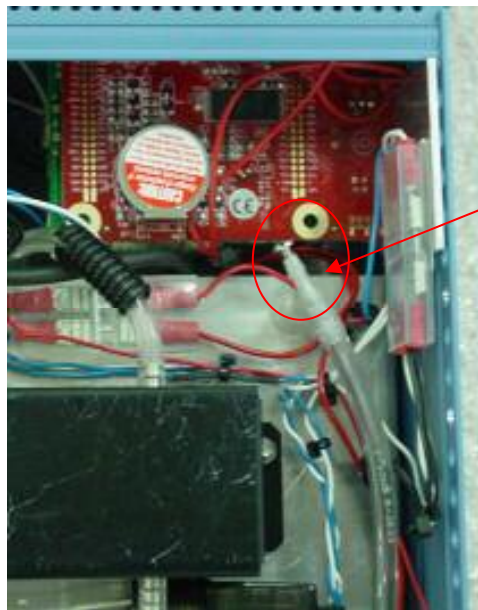

Particle Counter flow adjustment screw

Zero Check

It is recommended to periodically perform a zero count test as described below. False counts caused by air leaks or spurious noise will cause errors that are especially apparent when sampling relatively clean aerosols.

1. Attach a filter with a rating of 0.45µm or better to the particle inlet nozzle. The filter must be large enough that it does not create a restriction and load down the small vacuum pump inside the IQM. One zero particulate filter is supplied with the IQM.
2. Since the air passing through the IQM is now virtually particle free the output particle count should be zero. If it is not, check for leaks around the tubing to the particle counter.

Span Calibration

There are no user serviceable components inside the particle counter instrument. The cover on the particle counter should not be removed or opened for servicing, calibration or any other purpose except by a factory authorized person. To do so will void warranty and may result in exposure to invisible laser radiation that can cause blindness. Contact Aeroqual for service information. Calibrating particle sensors like the one in the IQM requires specialized equipment and a skilled technician. The particle counter should be factory calibrated on a yearly basis.

Appendix A AQM V5.x Software Instructions

Description

The AQM V5.x Software is designed to be a simple interface for communicating with the IQM monitor via a PC. It can be used to configure the IQM, initiate the zero calibration routine, modify gain factors, poll data and display the data in either table or graphical format. The software runs in Java VM1.5 (supplied with software) and the database is an open source HSQLDB Java database. Data can be easily exported to a spreadsheet for manipulation. The software also incorporates a GSM modem connection which can be used to connect to and operate an IQM unit remotely.

The software is compatible with IQM firmware versions 4.0 and higher only.

Computer Requirements

- CD-ROM Drive
- RS232 port
- Windows OS version 2000 or later
- 100 Mb of spare hard drive space
- recommended 256 Mb RAM
- recommended 1 GHz processor speed

Setting up

1. Install IQM CD into drive and extract the "Aeroqual AQM V5.x for Vista" or launch the AQM_4.x.exe software if you have earlier versions of Windows OS.
2. Launch software
 - Click Setup---> *COM Port*.
 - Select correct COM port settings *Port, 38400, 8, 1, N, N*
 - Click *OK*

Passwords

The factory set passwords for the IQM are:

System password:	password
Diagnostic password:	george

Menu Descriptions

File



Search monitor

Searches for available IQM monitors.

Start Data Logging

Starts data logging from the IQM monitor.

Stop Data Logging

Stops data logging from the IQM monitor.

Export Logged Data

Exports logged data from the IQM monitor.

Import Files

Imports file (aql file).

Download Files

Downloads files from the IQM; including daily files and event log (see below)

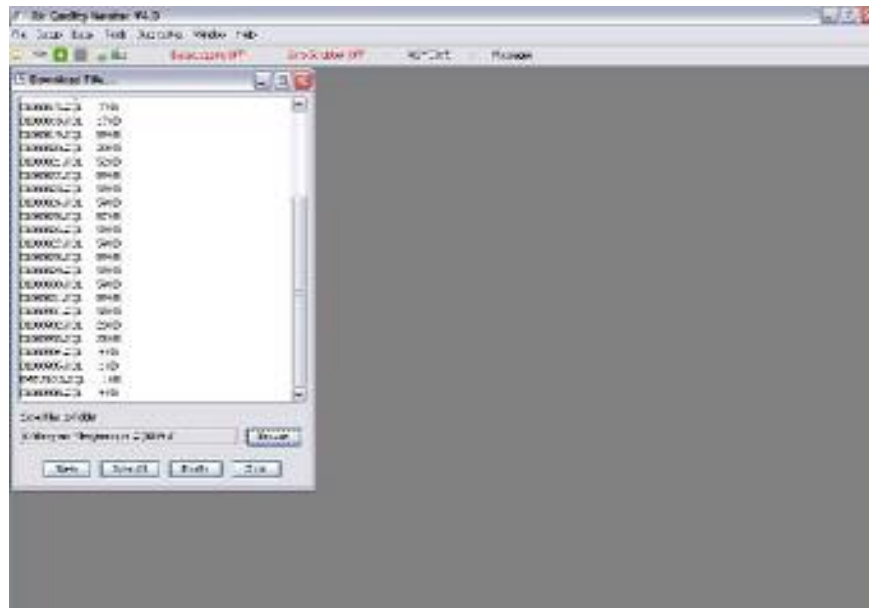

Update sensor list

updates the sensor list on the database.

Zip database

zips the database.

Unzip database

Unzips the database (prompted by a warning message). (See below)

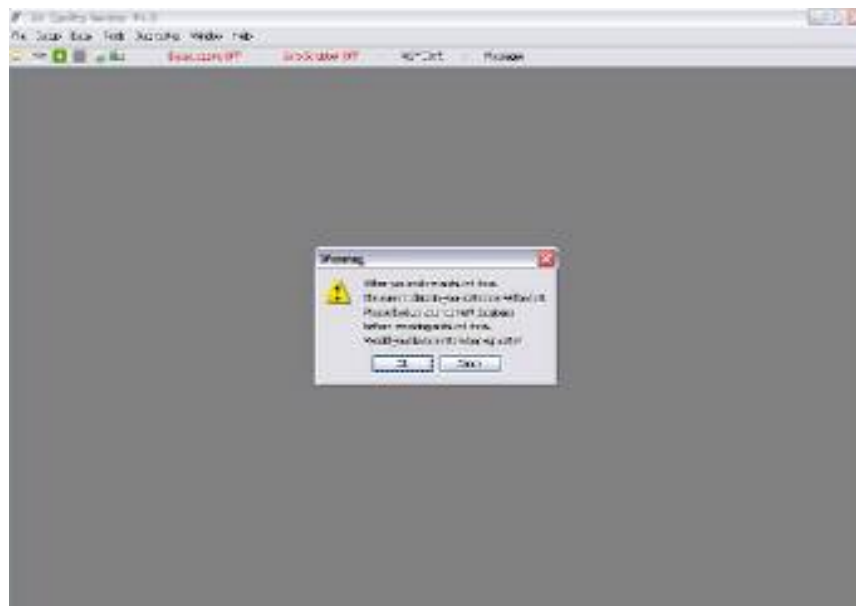

Exit Ctrl X

Exits the AQM software.

Operations Changes the operation of the IQM. (See below)

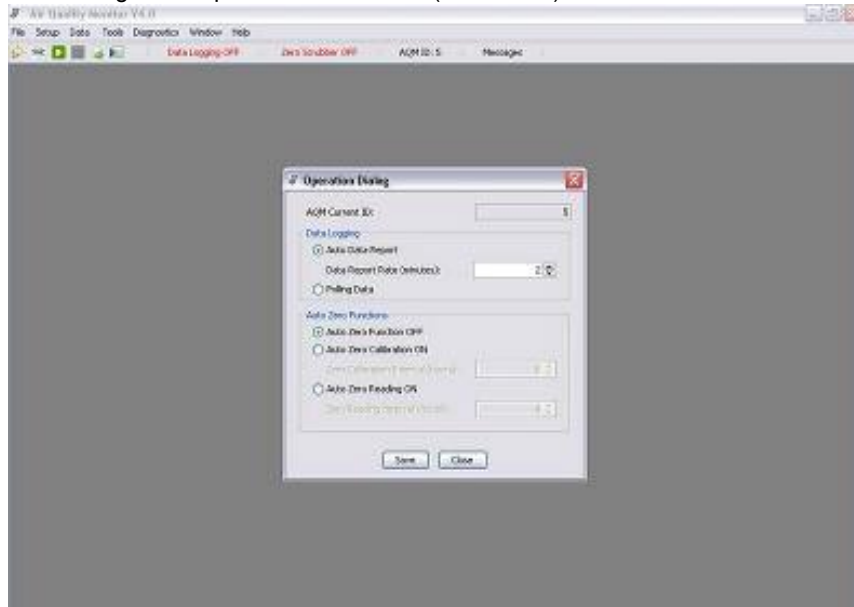

Test Connection Tests the connection to the IQM monitor. (See below)

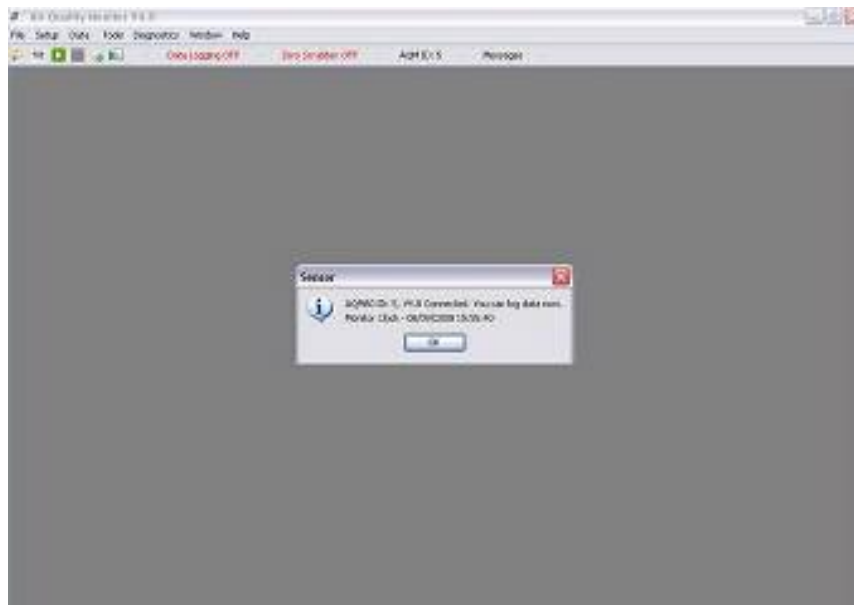

COM Port Ctrl M

Configures the COM port for communicating with the IQM Monitor. (See below)

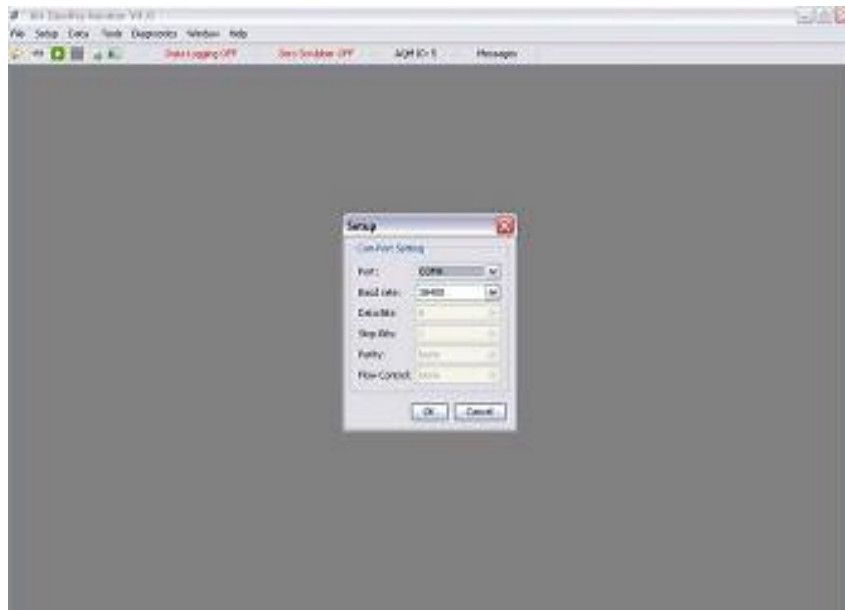

Data



Graph --> Real Time Graphs real time data from the IQM Monitor. (See below)

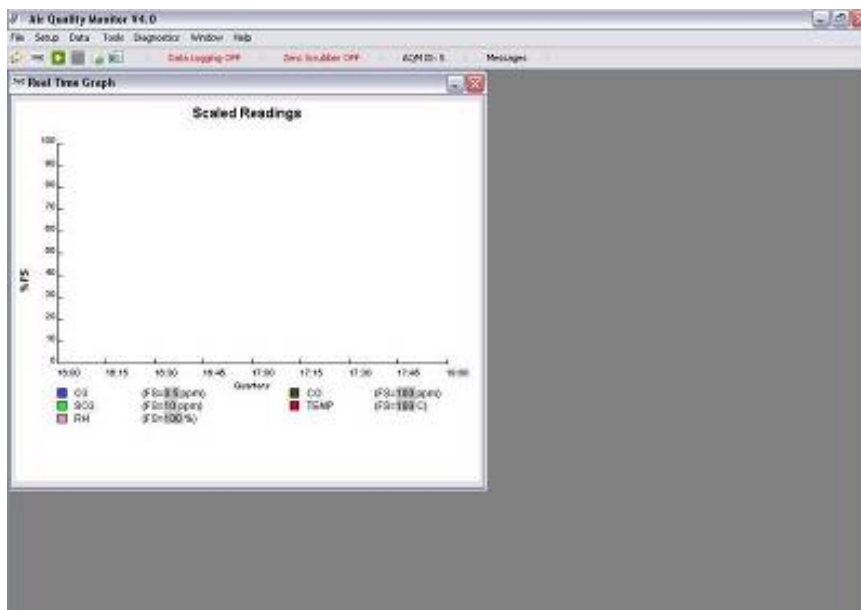

Graph --> Logged Data Graphs Logged data from the IQM Monitor. (See below)

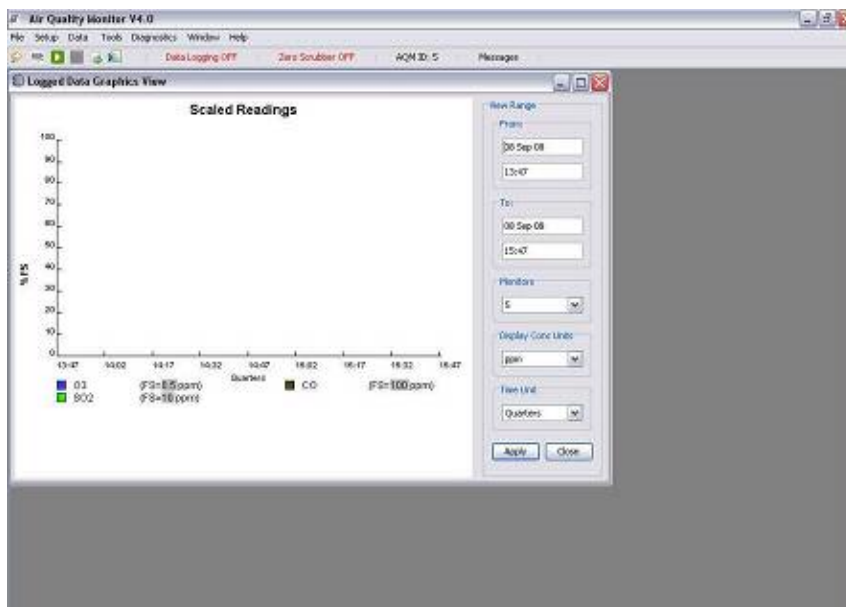
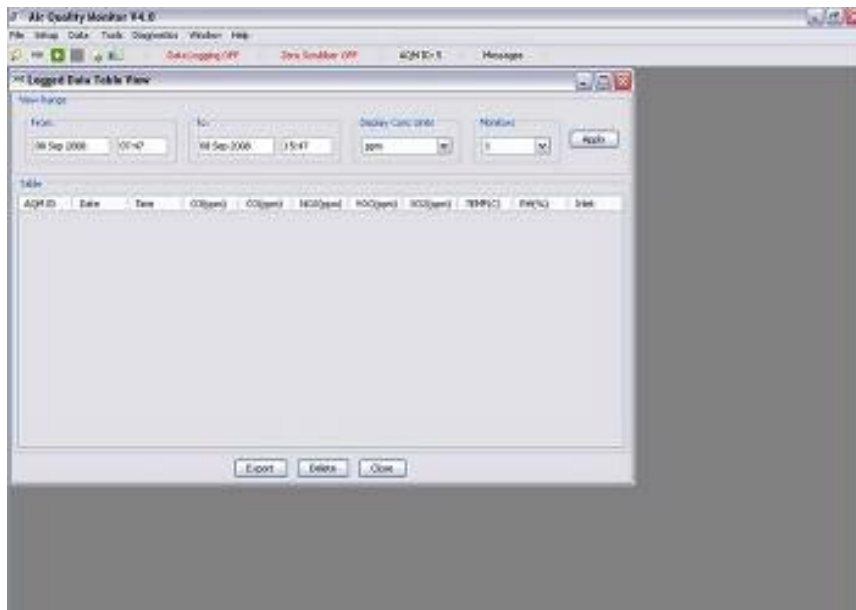
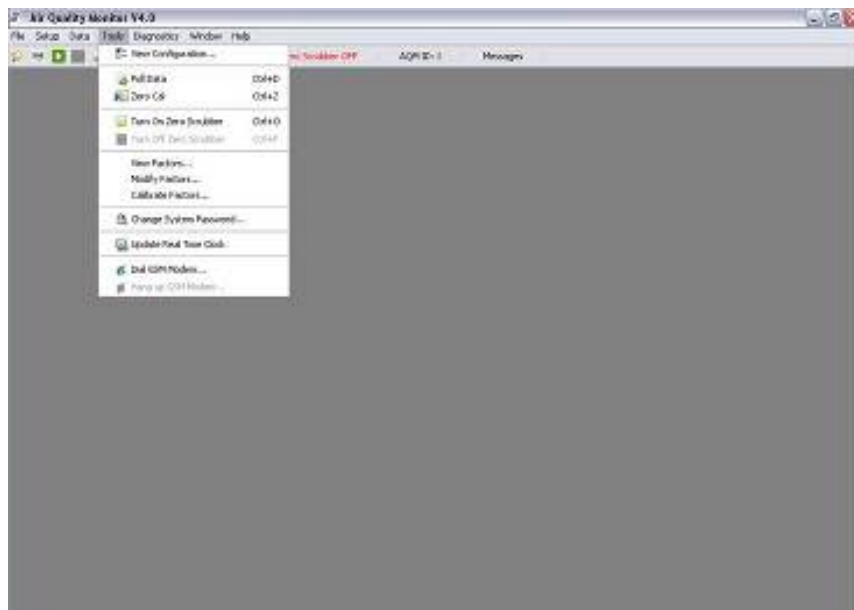

Table --> Logged data tabulates the logged data from the IQM monitor. (See below)



Tools



View Configuration Views the configuration settings of the IQM monitor. (See below)

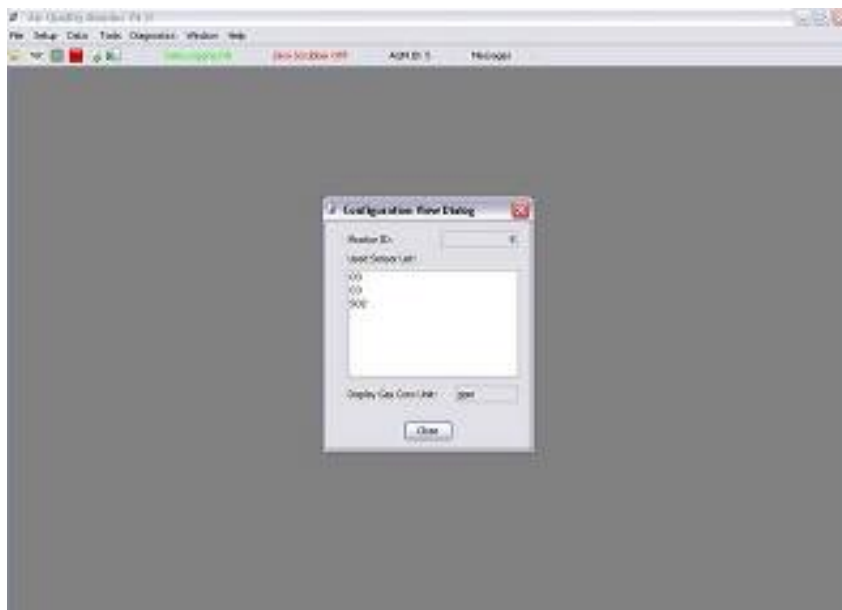

- Poll Data Ctrl D Polls data from the IQM monitor (data will appear either in the real time table or real time graph depending on which is open).

- Zero Cal Ctrl Z Zero Calibrates the IQM monitor (requires system password).
- Turn On Zero Scrubber Ctrl O Turns on the zero scrubber.
- Turn Off Zero Scrubber Ctrl F Turns off the zero scrubber.
- View Factors Views the calibration factors of the individual sensors in the IQM monitor. (See below)

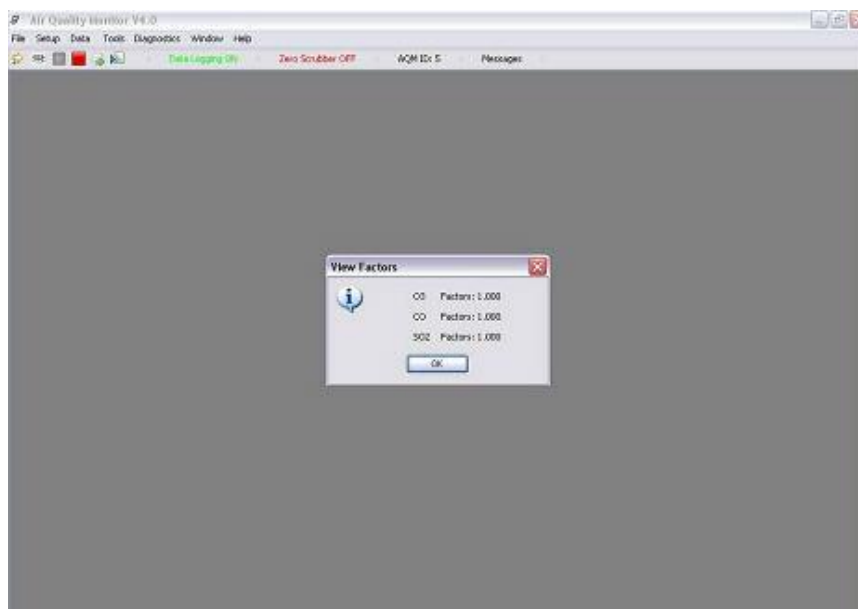

Modify Factors
menu

Modifies the calibration factors of the individual sensors in the IQM monitor (requires system password). Sensors selectable from a drop down

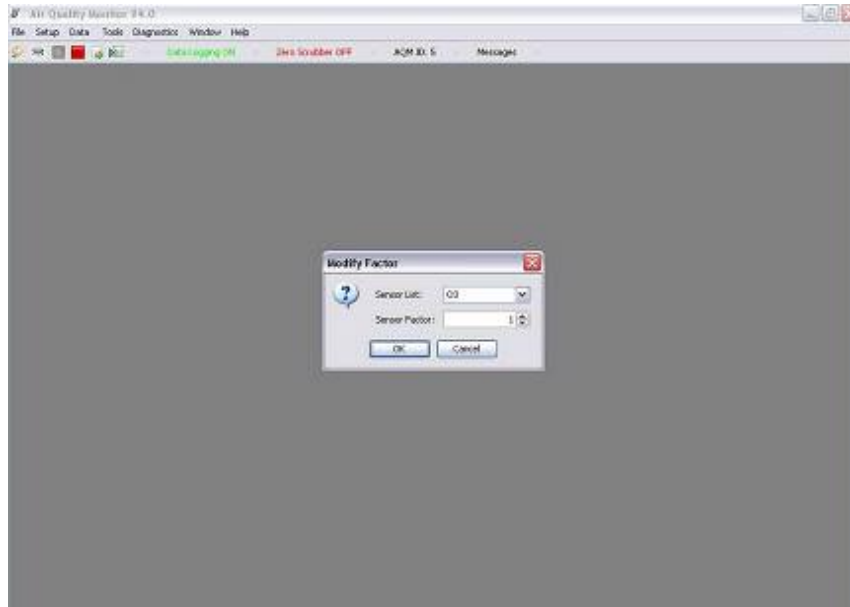

Calibrate Factors

Sets the span calibration point of the individual sensors in the IQM monitor (requires system password).

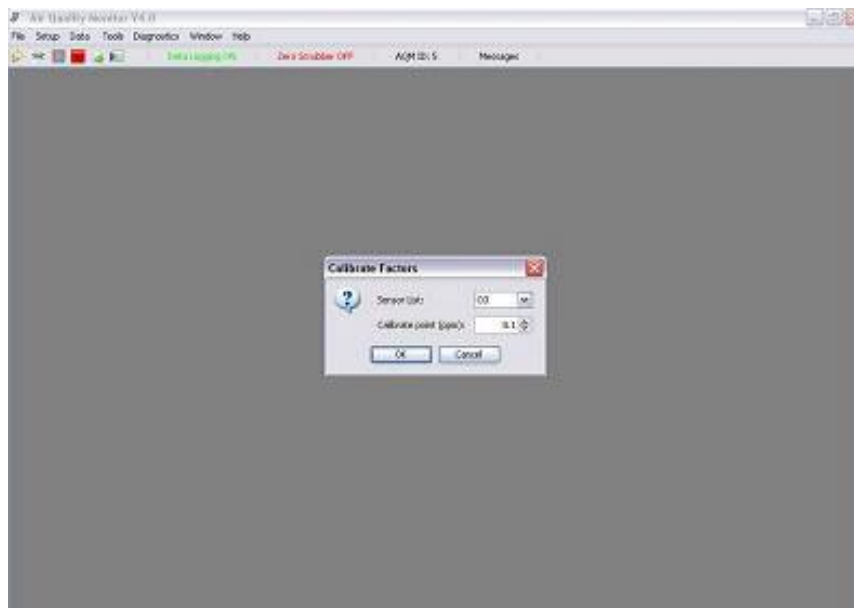

Dial GSM Modem Dials the GSM Modem (if applicable).

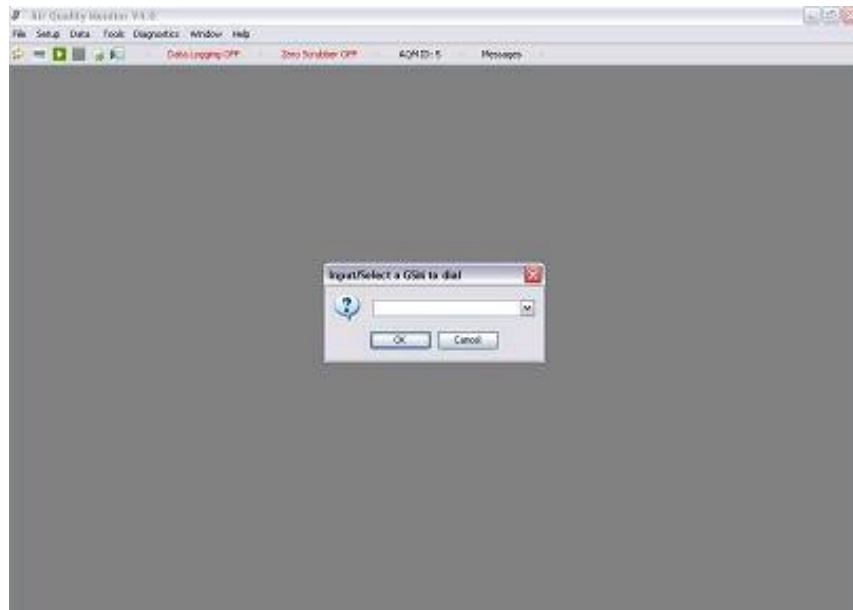

Hang up GSM Modem Hangs up the GSM modem.

Diagnostics



Sensor Module Settings

Displays the sensor module settings (requires diagnostic password).



Caution: incorrect modification of sensor module settings may cause irreversible damage. Do not change settings without contacting Aeroqual or a qualified service agent.

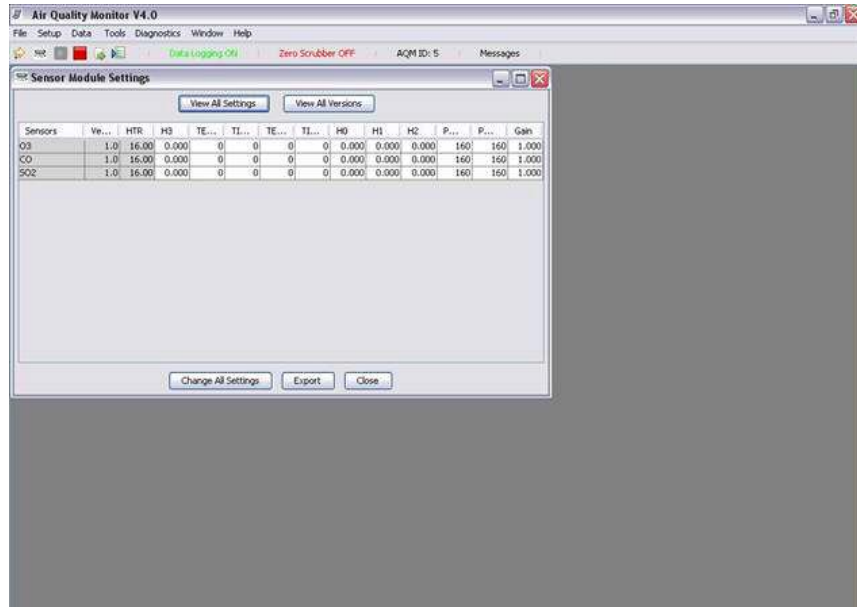

Sensor Diagnostics View

Displays the sensor module diagnostic view (exportable to text file).

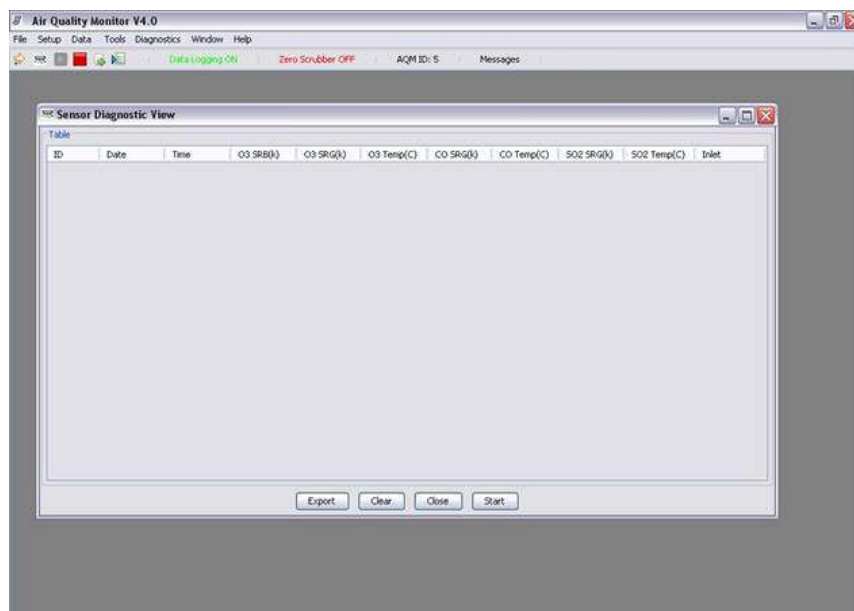

Window



Full Screen Display Toggles between full screen display and other open windows. (See below)

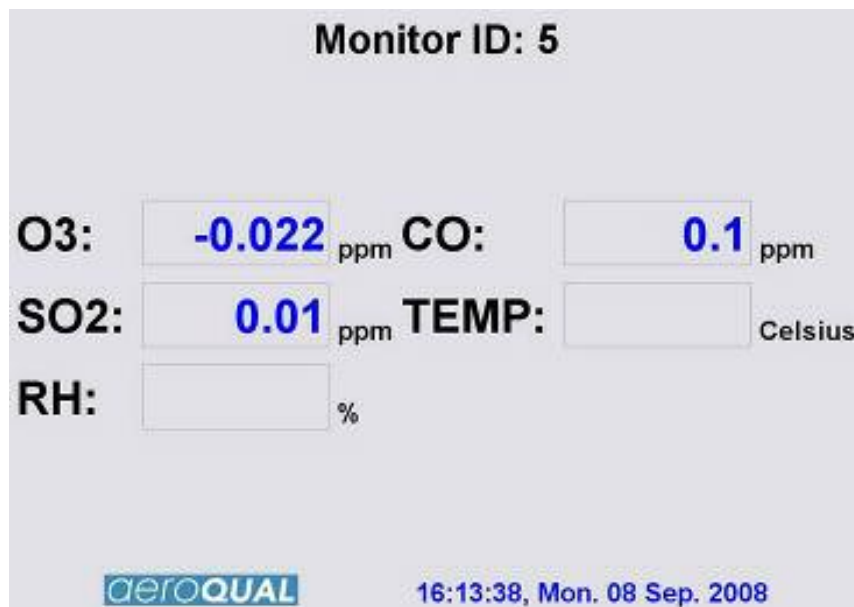

Appendix B Communication Protocol

The AQM monitor information output is based on RS232 protocol. These command protocols are specified by Aeroqual Limited. Aeroqual reserves the right to change the protocol without notification. All rights reserved.

Glossary: AQM - stands for Air Quality Monitor that includes both outdoor and indoor Air Quality monitors.

Version 4.0, This version is not back compatible with previous versions 3.6,3.7,3.8,3.9, on 18/06/2008

- ** Extended Protocol with AQM ID combined with data logging.
- ** Added AQM ID in the property information. See command 10 for details.
- ** Added zero calibration status polling command.
- ** separate configurations to AQM configuration and operation settings.
- ** Added sensor ppm to mg/m3 conversion factor setting command.

The AQM controller master can only take max of 14 sensors, which include temperature, relative humidity sensors and Auxiliary modules as well.

Section 1.

General descriptions of communication commands. Command streams are binary, and all command, data use hexadecimal byte as representation. Comma and spaces are not applied for every command and reply data stream, they are just used for clearly specifying data stream:

1. Sensor reading request command sent out from PC or other data receiver, its format is a 4 bytes stream:

MONITOR, AQM_ID, SENSOR_TYPE, CHECKSUM

- * MONITOR - information request command header, its value is 0x55.
- * AQM_ID - 1 byte, AQM ID its value 1-255.
- * SENSOR_TYPE - gas concentration request command, please refer section 2 for details.
- * CHECKSUM - the data stream's check sum - that makes the command stream total bytes sum to be zero.

Example (To poll ozone reading): 0x55 0x01 0x30 0x7A

2. Sensor reading request command reply or auto data report command data stream, 15 bytes:

SENSOR, AQM_ID, SENSOR_TYPE, DATA, SENSOR_STATUS, RB_TIMESTAMP, CHECKSUM

- * SENSOR - 1 byte monitor reply data stream header, its value is 0xAA.
- * AQM_ID - 1 byte of AQM box ID, value is 1-255.
- * SENSOR_TYPE - 1 byte gas type, its value will be same as the request command value, see section 2 for details.
- * DATA - 4 bytes floating point data value. If the SENSOR_TYPE is gas sensor, the value is concentration in ppm. If the value is 9999, this means the corresponding sensor didn't give reading. Please refer to Section 2 for detail.
- * SENSOR_STATUS - 1 byte sensor status indication, refer section 3 for details.
- * RB_TIMESTAMP - 6 bytes timestamp, in the format of ss:mm:hh DD-MM-YY, each field is 1 byte, or all zero with no timestamp for SM50 basic controller.
- * CHECKSUM - 1 byte the data stream's check sum - that makes the command stream total bytes sum be zero.

3. AQM Monitor property configuration command, 4 bytes, followed by 19 bytes configuration data stream (since V5.0):

MONITOR, AQM_ID, SET_CONFIGURATION, CHECKSUM

- * SET_CONFIGURATION - 1 byte command to configure AQM controller.

MONITOR, AQM_ID, SENSOR_NUM, SENSOR_1, SENSOR_2, SENSOR_3, SENSOR_4, SENSOR_5, SENSOR_6, SENSOR_7, SENSOR_8,

SENSOR_9, SENSOR_10, SENSOR_11, SENSOR_12, SENSOR_13, SENSOR_14,
AQM_STATUS, CHECKSUM

- * AQM_ID - 1 byte value, indicate the AQM ID number, which range is 1 - 255.
- * SENSOR_NUM - 1 byte, specify the valid numbers of sensor has been used by the AQM box.
- * SENSOR_1, SENSOR_2, SENSOR_3, SENSOR_4, SENSOR_5, SENSOR_6, SENSOR_7,
SENSOR_8,
SENSOR_9, SENSOR_10, SENSOR_11, SENSOR_12, SENSOR_13, SENSOR_14, - Specifies the
sensor type has been
used for the AQM box. The value will be any of Sensor type value.
- * AQM_STATUS - 1 byte, used specify AQM auto report data and auto zero calibration, see section 2 for
details.

Example: 0x55 01 19 91
Followed by: 0x55 01 05 30 40 50 65 B0 00 00 00 00 00 00 00 03 CD

3A. Configuring AQM property acknowledgement command, 4 bytes:

SENSOR, AQM_ID, SET_CONFIGURATION, CHECKSUM

4. Request AQM Monitor property configuration command, 4 bytes,

MONITOR, AQM_ID, GET_CONFIGURATION, CHECKSUM

- * GET_CONFIGURATION - 1 byte configuration request command, its value please see section 2.

Example: 0x55 0x01 0x18 0x92

5. Request AQM Monitor configuration command reply, 19 bytes (since V5.0):

SENSOR, AQM_ID, SENSOR_NUM, SENSOR_1, SENSOR_2, SENSOR_3, SENSOR_4, SENSOR_5,
SENSOR_6, SENSOR_7, SENSOR_8,
SENSOR_9, SENSOR_10, SENSOR_11, SENSOR_12, SENSOR_13, SENSOR_14,
AQM_STATUS, CHECKSUM

- * AQM_ID - 1 byte value, indicate the AQM ID number, which range is 1 - 255.
- * SENSOR_NUM - 1 byte, specify the valid numbers of sensor has been used by the AQM box, max
number is 14.
- * SENSOR_1, SENSOR_2, SENSOR_3, SENSOR_4, SENSOR_5, SENSOR_6, SENSOR_7,
SENSOR_8, SENSOR_9, SENSOR_10, SENSOR_11, SENSOR_12, SENSOR_13, SENSOR_14, -
Specifies the sensor type has been
used for the AQM box. The value will be any of Sensor type value.
- * AQM_STATUS - 1 byte, used specify AQM auto report data and auto zero calibration, see section 2 for
details.

6. Set monitor operation settings command 4 bytes followed by 8 bytes,

MONITOR, AQM_ID, SET_OPERATION, CHECKSUM

MONITOR, AQM_ID, SET_OPERATION, AUTO_REPORT_RATE, ZERO_CAL_INTERVAL,
AUTO_ZERO_READ_FREQ, OPERATION_STATUS, CHECKSUM

- * SET_OPERATION - 1 byte command, see section 2 for values.
- * AUTO_REPORT_RATE - 1 byte, specify the auto data report rate in minutes maximum 255 minutes. It's
only valid, when AQM_STATUS bit 0 is 1.
- * ZERO_CAL_INTERVAL - 1 byte, specify the auto zero calibration interval in hours maximum 255 hours.
It's only valid, when AQM_STATUS bit 1 is 1.
- * AUTO_ZERO_READ_FREQ - 1 byte, specify the auto zero reading frequency in hours, max 255 hours.
It's only valid, when AQM_STATUS bit 2 is 1.
- * OPERATION_STATUS - 1 byte operation status, see section 2 for details.

6A. Acknowledge reply command of set operations, 4 bytes:

SENSOR, AQM_ID, SET_OPERATION, CHECKSUM

7. Get monitor operation settings command 4 bytes:

MONITOR, AQM_ID, GET_OPERATION, CHECKSUM

8. Reply command of get monitor operations, 8 bytes:

SENSOR, AQM_ID, GET_OPERATION, AUTO_REPORT_RATE, ZERO_CAL_INTERVAL,
AUTO_ZERO_READ_FREQ, OPERATION_STATUS, CHECKSUM

9. AQM Monitor information request command, 4 bytes:

MONITOR, AQM_ID, AQM_INFO, CHECKSUM

Example: 0x55 0x01 0xFB 0xAF

* AQM_INFO - 1 byte AQM information request command.

10. AQM monitor information reply command, 16 bytes:

SENSOR, AQM_ID, AQM_INFO, VERSION, NAME, RTC, CHECKSUM

* AQM_ID - 1 byte value, indicate the AQM ID number, which range is 1 - 255.

* AQM_INFO - 1 byte sensor information request command, see section 2 for its value.

* VERSION - 1 byte, its unsigned value divided by 10 gives the AQM box version number.

* NAME - 5 bytes, the monitor name ASCII code (AQM60/AQM10/IQM60).

* RTC - 6 bytes, the monitors Real Time Clock (each field is one byte), ss:mm:hh DD/MM/YY, the year is since 1900+YY

** User could use this command to test communications.

11. AQM Monitor zero calibration starts command 4 bytes:

MONITOR, AQM_ID, ZERO_CAL, CHECKSUM

* ZERO_CAL - 1 byte command to start the zero calibration for all gas sensor modules.

Example 0x55 0x01, 0x12 0x98

11A. Acknowledge reply command of Zero calibration, 4 bytes

SENSOR, AQM_ID, ZERO_CAL, CHECKSUM

12. Turn on Zero Scrubber command, 4 bytes:

MONITOR, AQM_ID, ZERO_SCRUBBER_ON, CHECKSUM

* ZERO_SCRUBBER_ON - 1 byte command to turn on zero scrubber.

Example 0x55 0x01 0x14 0x96

12A. Acknowledge reply command of Zero scrubber turn on acknowledge reply command, 4 bytes:

SENSOR, AQM_ID, ZERO_SCRUBBER_ON, CHECKSUM

13. Turn off Zero Scrubber command, 4 bytes:

* Set gain factor 1.0 for O3 sensor

17A. Acknowledge reply command of setting gain value, 4 bytes:

SENSOR, AQM_ID, SET_GAIN_FACTOR, CHECKSUM

18. Set sensor names for data logging and monitors with displays.

This is 4 bytes command, followed with 115 bytes with sensor code and name ASCII.

MONITOR, AQM_ID, SET_SENSOR_NAMES, CHECKSUM

MONITOR, AQM_ID, SENSOR_1, NAME_1, SENSOR_2, NAME_2, SENSOR_3, NAME_3, SENSOR_4,
NAME_4, SENSOR_5, NAME_5,
SENSOR_6, NAME_6, SENSOR_7, NAME_7, SENSOR_8, NAME_8, SENSOR_9, NAME_9,
SENSOR_10, NAME_10,
SENSOR_11, NAME_11, SENSOR_12, NAME_12, SENSOR_13, NAME_13, SENSOR_14,
NAME_14, CHECKSUM

* SET_SENSOR_NAMES - 1 byte command to set sensor names, refer section 2 for its value.

* SENSOR_1 ~ SENSOR_14 - 1 byte Specified sensor type has been used for the monitor.

* NAME_1 ~ NAME_14 - are the names of sensors. They are in ASCII format 7 char each, less than 7
USE blank char instead.

18A. Acknowledge reply command for setting sensor names, 4 bytes:

SENSOR, AQM_ID, SET_SENSOR_NAMES, CHECKSUM

19. Set concentration valid decimal numbers for monitors with display.

This is 4 bytes command, followed with 31 bytes sensor code and decimal numbers.

MONITOR, AQM_ID, SET_DECIMAL_NUMS, CHECKSUM

MONITOR, AQM_ID, SENSOR_1, DECIMAL_1, SENSOR_2, DECIMAL_2, SENSOR_3, DECIMAL_3,
SENSOR_4, DECIMAL_4, SENSOR_5, DECIMAL_5,
SENSOR_6, DECIMAL_6, SENSOR_7, DECIMAL_7, SENSOR_8, DECIMAL_8, SENSOR_9,
DECIMAL_9, SENSOR_10, DECIMAL_10,
SENSOR_11, DECIMAL_11, SENSOR_12, DECIMAL_12, SENSOR_13, DECIMAL_13, SENSOR_14,
DECIMAL_14, CHECKSUM

* SET_DECIMAL_NUMS - 1 byte command to set valid fraction digits for all the sensor readings.

* SENSOR_1 ~ SENSOR_14, - 1 byte each, sensor type code has been used for the monitor.

* DECIMAL_1 ~ DECIMAL_14 - 1 byte each, which is the values of decimal numbers for the sensor valid
reading.

19A. Acknowledge reply command for setting valid decimal numbers, 4 bytes:

SENSOR, AQM_ID, SET_DECIMAL_NUMS, CHECKSUM

20. AQM Monitor zero calibration status information request command, 4 bytes:

MONITOR, AQM_ID, ZERO_INFO, CHECKSUM

Example: 0x55 0x01 0xFC 0xAE

* ZERO_INFO - 1 byte zero calibration status information request command.

21. AQM monitor zero calibration status information reply command, 4 bytes:

SENSOR, AQM_ID, ZERO_INFO, ZERO_STATUS, CHECKSUM

- * ZERO_INFO - 1 byte zero calibration status,
- * ZERO_STATUS- 1 byte = 0x00, zero calibration finished or not zero calibration state, else the zero calibration was processing.

22. AQM Monitor real time clock update command, 4 bytes, followed by 10 bytes real time data:

MONITOR, AQM_ID, SET_RTC, CHECKSUM

MONITOR, SET_RTC, RTC, CHECKSUM

- * SET_RTC - 1 byte update Real Time Clock command.
- * RTC - 7 bytes Real Time clock, ss:mm:hh dd/MM/YY WD(Week Day)

22A. Acknowledge reply command of updating real time clock, 4 bytes:

SENSOR, AQM_ID, SET_RTC, CHECKSUM

23. Get all logged file name list from SD card command, 4 bytes:

MONITOR, AQM_ID, GET_FILE_NAME_LIST, CHECKSUM

- * GET_FILE_NAME_LIST - command to get file name list.

24. Reply of the above command is 20 bytes stream. The command requester could get many of this reply. Each of them is a individual file. Until 3 seconds time up, without any reply:

SENSOR, AQM_ID, GET_FILE_NAME_LIST, FILE_NAME, FILE_SIZE, CHECKSUM

- * FILE_NAME - 12 bytes ASCII code of the full file name.
- * FILE_SIZE - 4 bytes long integer value of the file size.

25. Download a logged file in SD card via serial port, the command is 4 bytes:

MONITOR, AQM_ID, DOWNLOAD_A_FILE, CHECKSUM

- * DOWNLOAD_A_FILE - 1 byte command

Followed by 16 bytes stream with file name:

MONITOR, AQM_ID, DOWNLOAD_A_FILE, FILE_NAME, CHECKSUM

- * FILE_NAME - 12 bytes ASCII code of a full file name.

Reply data stream is ASCII coded data record, with tab delimited (t) and new line ends, receiver just simply look for line ends (\n):

Example file data:

```

AQM ID: 255\n
Date          Time      Sensor1 Sensor2 ...      SensorX Inlet\n      *File header with tab
delimited
 16/11/07     10:12:00 0.026   10.6   ...      2.8      S\n      *Date, time and readings
with tab delimited
 16/11/07     10:14:00 0.028   9.8    ...      2.6      S\n      *Date, time and readings
with tab delimited

```

- * Sensor1 ~ SensorX - sensor name ASCII with tab delimited.
- * 16/11/07 - 8 bytes date ASCII, 16 Nov. 2007
- * 10:12:00 - 8 bytes time ASCII, hour:minutes:seconds
- * 0.26, 10.6 - 8 bytes decimal value in ASCII
- * S - 1 byte inlet state, S for Sample, Z for Zero air scrubber on

26 Delete a file in SD card command, 4 bytes followed by 15 bytes with file name:

MONITOR, AQM_ID, DELETE_A_FILE, CHECKSUM

* DELETE_A_FILE - 1 byte command to delete a file in data logging card.

Followed by 16 bytes stream with file name:

MONITOR, AQM_ID, DELETE_A_FILE, FILE_NAME, CHECKSUM

* FILE_NAME - 12 bytes ASCII code of a full file name.

26A. Acknowledge reply command to confirm the file delete operation was successful.

SENSOR, AQM_ID, DELETE_A_FILE, CHECKSUM

27. Set sensor conversion factors for display gas reading in unit of mg/m3.

This is 4 bytes command, followed by 73 bytes:

MONITOR, AQM_ID, SET_CONVERSION_FACTOR, CHECKSUM

MONITOR, AQM_ID, SENSOR_1, FACTOR_1, SENSOR_2, FACTOR_2, SENSOR_3, FACTOR_3,
SENSOR_4, FACTOR_4, SENSOR_5, FACTOR_5,

SENSOR_6, FACTOR_6, SENSOR_7, FACTOR_7, SENSOR_8, FACTOR_8, SENSOR_9,
FACTOR_9, SENSOR_10, FACTOR_10,

SENSOR_11, FACTOR_11, SENSOR_12, FACTOR_12, SENSOR_13, FACTOR_13, SENSOR_14,
FACTOR_14, CHECKSUM

* SET_CONVERSION_FACTOR - 1 byte command to set sensor conversion factors, refer section 2 for its value.

* SENSOR_1 ~ SENSOR_14 - 1 byte Specified sensor type has been used for the monitor.

* FACTOR_1 ~ FACTOR_14 - 4 bytes floating point values.

27A. Acknowledge reply command for setting sensor conversion factors, 4 bytes:

SENSOR, AQM_ID, SET_CONVERSION_FACTOR, CHECKSUM

* SET_CONVERSION_FACTOR - 1 byte command to set sensor conversion factors, refer section 2 for its value.

28. Get sensor module version information command 4 bytes:

MONITOR, AQM_ID, GET_SENSOR_VERSION, SENSOR_CODE

* GET_SESNOR_VERSION - 1 byte command to get sensor module version info, refer section 2 for its value.

* SENSOR_CODE - 1 byte specific sensor code

29. Sensor module version info reply command 15 bytes:

SENSOR, AQM_ID, GET_SENSOR_VERSION, SENSOR_CODE, VERSION_NUM, DISP_TYPE,
NAME_LENGTH, NAME_ASCII, CHECKSUM

* GET_SESNOR_VERSION - 1 byte command to get sensor module version info, refer section 2 for its value.

* SENSOR_CODE - 1 byte specific sensor code

* VERSION_NUM - 1 byte sensor version number scaled up by 10, so its real number is
VERSION_NUM/10.

* NAME_LENGTH - 1 byte specifies the sensor's name valid ASCII code length.

* NAME_ASCII - 7 bytes ASCII code of sensor name, its valid length is specified by NAME_LENGTH.

***** Aeroqual internal use only (since V5.0) *****

28*. Download a specific sensor calibration parameters command, 4 bytes .

Example (To poll ozone sensor resistance): 0x55 0x01 0x0E 0x9C

34*. Sensor resistance request command reply data stream, 15 bytes:

SENSOR, AQM_ID, SENSOR_TEMP, SENSOR_TYPE, TEMPERATURE, RESERVED4,
SENSOR_STATUS, RESERVED, CHECKSUM

- * SENSOR - 1 byte monitor reply data stream header, its value is 0xAA.
- * SENSOR_TYPE - 1 byte gas type, its value will be same as the request command value, see section 2 for details.
- * SENSOR_TEMP - 1 byte command (0x0E)
- * TEMPERATURE - 4 bytes floating point data value, sensor heater temperature.
- * RESERVED - 1 byte reserved space.
- * SENSOR_STATUS - 1 byte sensor status indication, refer section 3 for details.
- * CHECKSUM - 1 byte the data stream's check sum - that makes the command stream total bytes sum be zero.

Command values:

SENSOR_PARAM_DOWNLOAD = 0x18
SENSOR_PARAM_UPLOAD = 0x19
SENSOR_RESISTANCE = 0x0D
SENSOR_TEMP = 0x0E
***** END *****

Section 2.

Protocol command values:

MONITOR = 0x55 header command used for receiver command
SENSOR = 0xAA header command used for monitor reply

GET_CONFIGURATION = 0x08 Request configure of AQM box command
SET_CONFIGURATION = 0x09 Configure AQM box command

GET_OPERATION = 0x06 Set AQM box operation command
SET_OPERATION = 0x07 Get AQM box operation command

GET_FILE_NAME_LIST = 0x0A Get all file name list command
DOWNLOAD_A_FILE = 0x0B Download a file from SD card command
DELETE_A_FILE = 0x0C Delete a file in SD card command

ZERO_CAL = 0x12 Zero calibration command
SPAN_CAL = 0x13 do span calibration
ZERO_SCRUBBER_ON = 0x14 Turn on zero scrubber
ZERO_SCRUBBER_OFF = 0x15 Turn off zero scrubber
GET_GAIN_FACTORS = 0x16 request span calibration values
SET_GAIN_FACTOR = 0x17 Set sensor gain factor

SET_SENSOR_NAMES = 0x1C Set sensor names
SET_DECIMAL_NUMS = 0x1D Set sensor concentration display decimal points number
SET_RTC = 0x1E Set AQM monitor Real Time Clock.
SET_CONVERSION_FACTOR = 0xFA Set sensor ppm to mg/m3 conversion factors.
AQM_INFO = 0xFB AQM monitor information request command.
ZERO_INFO = 0xFC Zero calibration status request command

SENSOR_TYPE These values defined a sensor type respectively. Some type of sensors can be extended up to 4 more subtypes, such as, NO2 can extend to 0x51, 0x52, 0x53. Some of can one only extend 1 subtype for reserving. However, every extended sensor type need a special program. Therefore the value can be any of the followings and their extensions (Aeroqual may update the sensor coding):

extend = 0x30 //O3 High, Low, Ultra Low concentration data request command - can extend
 = 0x40 //CO concentration data request command - can extend
 = 0x50 //NO2 concentration data request command - can extend
 = 0x55 //NO2 Ozone scrubber temperature request command, related with
 NO2 only
 = 0x60 //VOC concentration data request command - can extend
 = 0x61 //NMHC concentration data request command
 = 0x62 //VOC LOW concentration data request command
 = 0x65 //C6H6 BENZ concentration data request command - can extend
 = 0x70 //H2S concentration data request command - can extend
 = 0x80 //PERC concentration data request command - can extend
 = 0x82 //CH4 methane concentration data request command - can extend
 = 0x90 //NH3 concentration data request command - can extend
 = 0x91 //NH3 LOW (0-100) concentration data request command.
 = 0xA0 //HC12 concentration data request command - can extend
 = 0xB0 //SO2 concentration data request command - can extend
 = 0xB2 //SO2 HIGH concentration data request command - can extend
 = 0xB5 //CO2 concentration data request command - can extend
 = 0xBA //IPA concentration data request command - can extend
 = 0xC0 //H2O2 concentration data request command - can extend
 = 0xC5 //ETAC concentration data request command - can extend
 = 0xCA //H2 concentration data request command - can extend
 = 0xD0 //PROP concentration data request command - can extend
 = 0xD5 //PID gas sensor concentration data request command - can extend
 = 0xD9 //PM10 ug/m3, Particle monitor reading request command
 //used for auxiliary module, analogue ADC are 10 bits resolution
 = 0xDA //WS - Wind Speed, data request command, sin wave signal
 input(max 32kHz), result is wind speed in meter/second or can be frequency in Hz(require special
 program).
 = 0xDB //WD - Wind Direction, data request command, analogue input 0-5V,
 result is degree angles relative to zero point or voltage (require special program).
 = 0xDC //SR/AX1, data request command, analogue input 0-34mV with gain
 of 144, result is voltage in mV.
 = 0xDD //AX2, data request command, analogue input 0-450mV with gain of
 11, result is voltage in mV.
 = 0xDE //AX3, data request command, analogue input 0-5V without gain,
 result is voltage in Volts.
 = 0xDF //AX4, data request command, sin wave signal input(max 32kHz),
 result is frequency in Hz.

 From below the gas type can only extend 1 subtype
 = 0xE0 Reserved gas concentration data request command - can extend 1
 = 0xE2 Reserved gas concentration data request command - can extend 1
 = 0xE4 Reserved gas concentration data request command - can extend 1
 = 0xE6 Reserved gas concentration data request command - can extend 1
 = 0xE8 Reserved gas concentration data request command - can extend 1

 = 0xF0 - 0xF5 are reserved command space
 = 0xF6 Temperature data request command - can extend 1
 = 0xF8 Relative humidity data request command - can extend 1
 from 0xFA are reserved for other commands, not for gas sensor type.

 RESERVED 1 byte reserved not been used for information transfer, can be 0x00
 RESERVED_2 2 bytes reserved
 RESERVED_3 3 bytes reserved
 RESERVED_4 4 bytes reserved

 CHECKSUM a data stream's check sum - that makes the command stream
 total bytes sum is zero.

 SENSOR_STATUS * 8 bits (b7b6b5b4b3b2b1b0) monitor and sensor status information

 SensorStatus * b0 = 1 sensor failure
 * b0 = 0 sensor working fine

Reserved	* b1 reserved no meaning at all	
PumpStatus with pump)	* b2 = 1 pump failed * b2 = 0 pump working well	(This bit function only apply for O3 sensors)
NO2_Scrubber	* b3 = 1 NO2 scrubber temperature too low, otherwise, works well	(This bit only related with NO2 sensor).
ZeroScrubber	* b4 = 1 zero air scrubber turned on, otherwise, its off	
Reserved	* b5 reserved no meaning at all	
Reserved	* b6 reserved no meaning at all	
Reserved	* b7 reserved no meaning at all	
AQM_STATUS	* 8 bits (b7b6b5b4b3b2b1b0) monitor configuration status information	
	* b0 = 0, means the AQM gas reading unit is ppm	
	* b0 = 1, means the AQM gas reading unit is mg/m3	
	* b1 ~ b7 reserved	
OPERATION_STATUS	* 8 bits (b7b6b5b4b3b2b1b0) monitor operation status information	
	* b0 = 0, means the AQM will only report data by polling individual sensor	
	* b0 = 1, means the AQM will auto report all sensor concentration at specified rate.	
	* b1 = 0, means the AQM will only do zero calibration by user command	
	* b1 = 1, means the AQM will auto do zero calibration at specified	
ZERO_CAL_INTERVAL.		
	* b2 = 0, means the AQM will not do auto zero readings.	
	* b2 = 1, means the AQM will do auto zero readings at specified	
AUTO_ZERO_READ_FREQ		
	time intervals. The zero reading time is fixed 15 minutes long.	
	* b3 ~ b7 reserved	

Section 3.

Data value format representation:

The floating point data values use standard IEEE754 32 bits floating point little ending representation, like DATA field.

Section 4.

Data transfer mechanism

1. Due to the monitor main chips feature, 2 byte int and 4 bytes float data send sequence are low byte first, high byte last.
2. For regular data report:

Once the monitor power on and after warming up (1 minute), it will regularly report measured result to RS232 serial port by default.

Section 5. RS232 communication port settings:

Baud rate:	38400
Data bits:	8
Stop bits:	1
Parity:	none
Flow control:	none

Section 6. EventLog.aql file specification:

1. Once AQM turned on the date and time will be logged in the file.
2. Sensor status will be logged in the event log file, when a sensor failure indicated.
3. When request a sensor readings and there is no reply, the sensor will be logged in the file to indicate the sensor module might be stop working.
4. Sensor module with pump, which failed status will be logged in the file.
5. If there is NO2 sensor module, the Ozone scrubber working status will be logged in the file.

Enclosure

(Note: the layout of the back panel can vary slightly depending on the product configuration)

External View

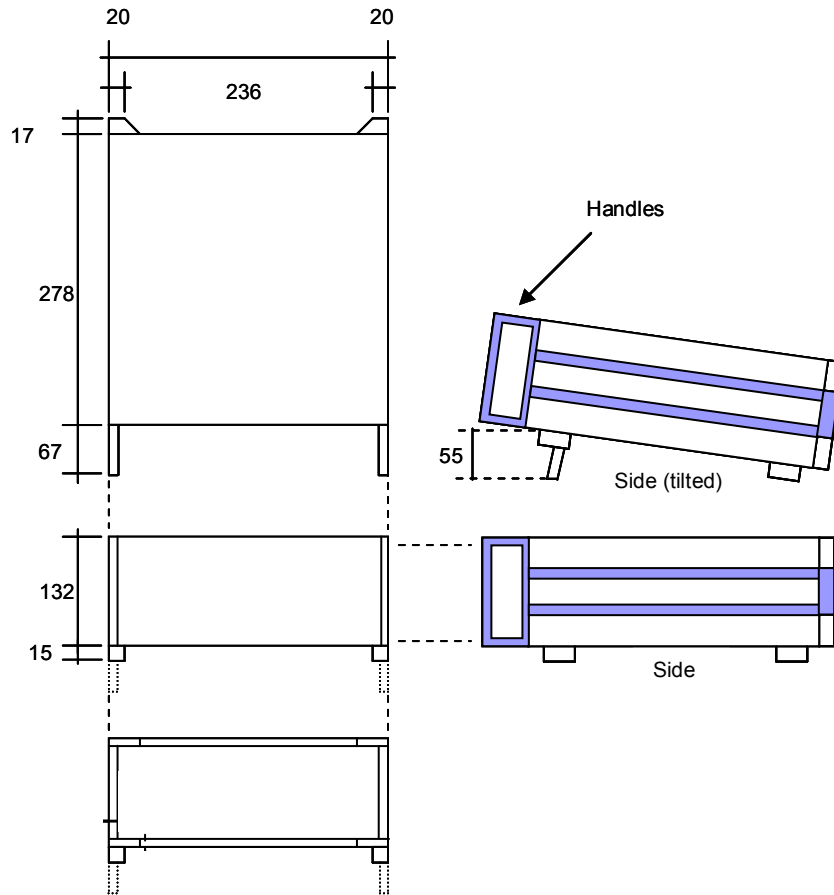

Description

Cast aluminum and pressed steel powder coated enclosure.

Dimensions

Basic enclosure size is:

236 mm W x 132 mm H x 278 mm D

The padded feet add 15mm to the depth and together with the two carry handles give the product an overall size of:

236 mm W x 148 mm H x 362 mm D

Front View



Rear View

